



MBC VARIABLE CHILLER USER MANUAL



TABLE OF CONTENTS

ABOUT THIS MANUAL	4	PUMPS	27
INTRODUCING THE MBC MARINE VARIABLE CHILLER SYSTEM	5	SENSORS, CLEAN SEA WATER CIRCULATION	28
PRODUCT INTRODUCTION, KEY COMPONENTS, SYSTEM OPERATION		TROUBLESHOOTING	29
GENERAL INSTALLATION GUIDELINES FOR CHILLER UNIT	6	OPERATION CONTROL	46
CHILLED WATER SYSTEM	8	LEGAL DISCLAIMERS AND LIABILITY, WARRANTY TERMS	58
INSTALLATION GUIDELINES FOR FRESH WATER SYSTEM	10		
STRAINER REQUIREMENTS, CLEANLINESS	11		
PIPE SIZE	12		
DROP WATER DRAIN, INSULATION OF CIRCULATION SYSTEM	13		
FRESH WATER CIRCULATION			
FILLING THE FRESHWATER CIRCUIT OF THE CHILLER SYSTEM	16		
INSTALLATION GUIDELINES FOR AIR HANDLER UNIT	18		
MOUNTING THE AIR HANDLER AND THE ELECTRICAL BOX	19		
SEAWATER SYSTEM INSTALLATION INSTRUCTIONS	21		
BEFORE THE FIRST START	24		
MAINTENANCE	25		

ABOUT THIS MANUAL

This manual provides comprehensive instructions for the correct installation of MBC Marine Variable Chilled Water Systems. It is crucial to follow these guidelines carefully, as improper installation can result in reduced system performance, premature equipment failure, and even serious injury or death. Be sure to read this manual thoroughly before starting any installation procedures.

Throughout this guide, you will encounter various symbols that indicate important information. Take a moment to familiarize yourself with these symbols and their meanings to ensure proper installation and safety.



SAFETY INFORMATION:

The manufacturer assumes no liability for any damage to the device in the following cases:

- Improper installation or connection of the system
- Damage caused by mechanical impact or overvoltage
- Unauthorized modifications made without the manufacturer's written consent
- Misuse or operation of the unit outside of standard guidelines



ELECTRICAL SHOCK WARNING:

Components of this unit are powered by 230 V AC during operation. Always disconnect the power supply at the main switchboard or power source before opening the unit box. Failure to do so could result in severe injury or death.

To minimize the risk of electrical shock, ensure the unit is properly grounded. This equipment meets relevant fire protection standards. Do not install the unit near gasoline engines, fuel tanks, LPG/CPG cylinders, or any other combustible materials.



SAFETY WARNING:

Do not install the air conditioning unit in any location where it could introduce carbon monoxide, exhaust gases, or other toxic substances into the vessel.



FIRE PROTECTION WARNING:

The installation and maintenance of this unit may be hazardous due to pressurized copper pipes and electrical components. Always follow safety precautions, including wearing protective goggles and work gloves. Keep a fire extinguisher nearby during installation and maintenance.



INTRODUCING THE MBC MARINE VARIABLE CHILLER SYSTEM

Thank you for choosing the **MBC Marine Variable Chiller System**, specifically designed to provide efficient cooling for multiple independent zones on your vessel. This advanced chilled water air conditioning system ensures optimal comfort and performance, featuring key components that work seamlessly together, including the chiller, air handlers, freshwater, and saltwater systems. Whether you're cooling or heating, the MBC Marine system offers superior climate control, tailored to meet the demanding needs of marine environments.

PRODUCT INTRODUCTION

To ensure a safe and successful installation, it is crucial to carefully read and follow the safety guidelines and instructions provided in this manual. If you have any questions or concerns, please reach out to MBC Marine Technical Service for assistance. Failure to comply with these warnings may result in system malfunction, serious injury, or even death.

MBC Marine is not responsible for damages in the following situations:

- Improper assembly or installation not in accordance with the manual.
- Damage due to mechanical impact or electrical overvoltage.
- Unauthorized modifications to the unit.
- Usage of the unit for purposes not specified in this manual.
- To ensure continuous improvement, MBC Marine reserves the right to modify system specifications and designs without prior notice.

KEY COMPONENTS

- **The Chiller (HC):** Contains the compressor, condenser, and evaporator or heat exchanger.
- **Air Handlers (AH):** Includes the blower and cooling coil.
- **Freshwater System:** Circulates freshwater from the chiller to each air handler and back.
- **Saltwater System:** Seawater passes through the condenser coil for heat exchange.

SYSTEM OPERATION

The system can be operated in two different modes.

Cooling Mode:

- The **blower** pulls warm, humid air from the cabin through the **air handler (AH)**.
- The air transfers heat to the freshwater circulating through the coil, cooling the air.
- The heated water is pumped back to the **chiller**, passing through the **evaporator**, where it transfers heat to the refrigerant.
- The refrigerant gas is compressed and passed through the **condenser coil**, transferring heat to seawater, which is expelled overboard.
- The chilled freshwater recirculates to the air handlers, continuing the cooling cycle.

Heating Mode:

- The process is reversed.
- The refrigerant flow is switched via a **reversing valve**, transferring heat from the freshwater system to the air handlers, providing heating.

GENERAL INSTALLATION GUIDELINES FOR CHILLER UNIT

Before starting the installation, carefully review these instructions and plan all necessary connections for the unit, including ducting, condensate drain line, seawater inlet and outlet hoses, electrical power supply, control panel placement, and seawater pump location. This planning will ensure easy access for installation and future maintenance of both the chilled water system and air handler units.

Unit Location:

The chiller unit is typically installed in the engine room. It must be placed on a stable, horizontal surface capable of supporting its weight when the boat is in motion. Ensure that the installation site is dry and allows for easy servicing. Maintain a clearance of 0.9 to 1.2 meters around the unit, with at least 0.9 meters of space above it.

Display Installation:

The digital control panel, should be installed on a dry, flat horizontal or vertical surface. Ensure easy access for installation and maintenance.

Electrical Connections:

Ensure proper grounding of the electrical connections, and always disconnect the power at the main switchboard before performing any maintenance work to avoid electric shock.

Working with this system involves potential hazards due to high-pressure components and electrical equipment. Always adhere to the safety guidelines outlined in the documentation, as well as the tags and labels on the equipment. Follow all safety regulations, wear safety goggles and work gloves, and keep a fire extinguisher nearby in the work area.

Condensate Drain:

Proper installation of the condensate drain connection is essential for the efficient operation of the system and to prevent water damage. Make sure the drain line is free of blockages and properly routed to avoid leaks.

Securing Piping:

All seawater and chilled water pipes should be securely fastened to prevent putting strain on the pump or other components. Avoid any loops or sharp bends in the pipes, as these can create air or water traps that may impede the system's performance.

Vibration Insulation:

It is recommended to use vibration-dampening materials to minimize noise and prevent vibrations from being transmitted to the boat's structure, which can reduce wear on the system and ensure smoother operation.

System Testing:

After installation, it is important to perform a pressure test on the system to ensure there are no leaks and that the system is operating within the proper parameters. This will help identify any issues before they become major problems.

Pressure Measuring Instrument

The pressure gauge on the MBC Variable Chiller unit is an essential tool for monitoring the system's operation. It allows for continuous tracking of the pressure within the chiller system and helps maintain the correct refrigerant levels.

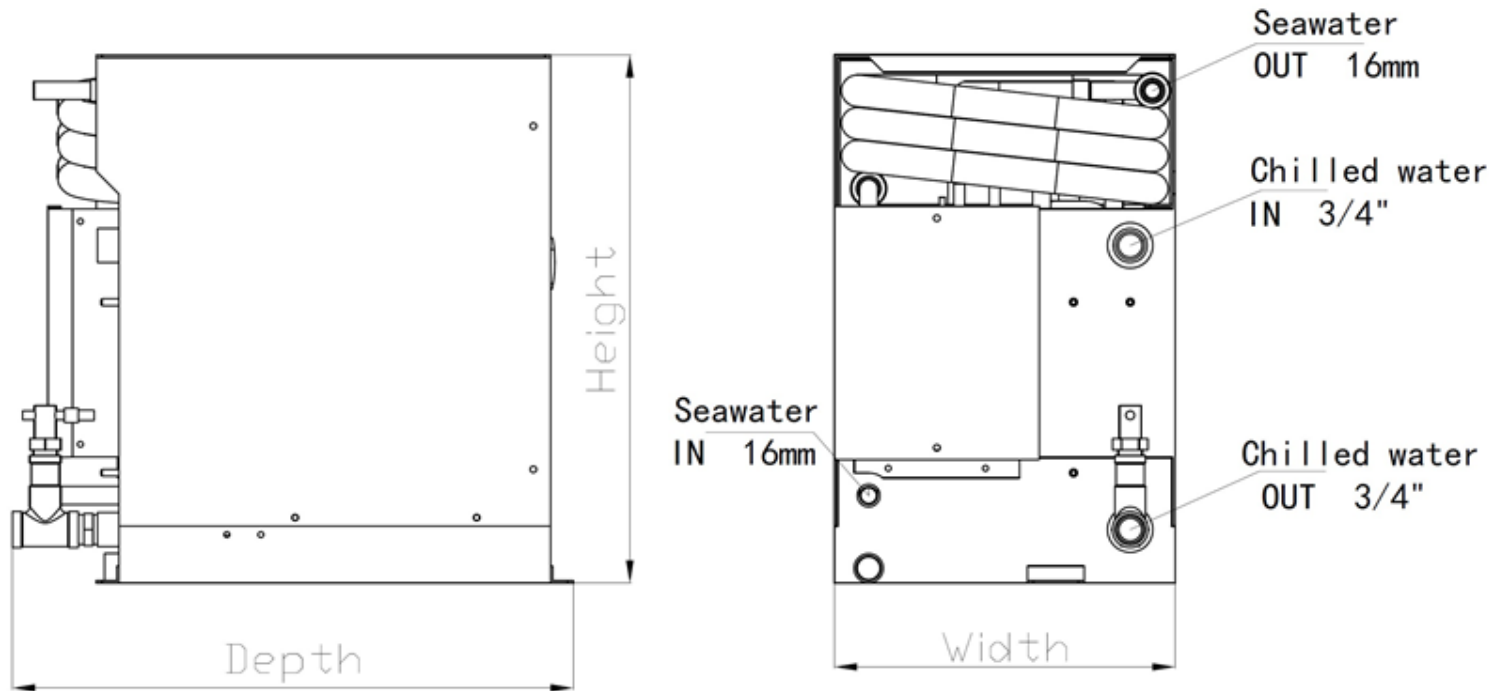

CHILLED WATER SYSTEM

Guidelines and important notices

Critical Notice:

Failure to maintain proper glycol levels can cause system damage and will void the warranty on your MBC units.

Adding Ethylene glycol:

Glycol must be added to the water after the system has been bled and any leaks have been repaired. Any brand can be used, but you must follow the manufacturer's recommendations. We recommend a 20% concentration of non-toxic, inhibited propylene glycol.

Glycol Warnings:

Do not use automotive glycol as it often contains additives that are highly corrosive to copper components.

Maintaining Freeze Point:

Ensure that the freeze point is maintained below -7°C , and regularly check glycol levels, particularly after water is lost or added. A refractometer can be used to measure the glycol concentration. Check the levels at least once per year.

Piping Material Guidelines:

For systems with PVC piping, the glycol concentration should not exceed 30%. For CPVC piping, it should not exceed 25%, as higher concentrations can damage these materials.

Insulation of Fresh Water Pipes:

Ensure thorough insulation of all pipes in the system to prevent condensation, which is a common issue in chilled water systems. Condensation can go unnoticed until it causes water damage. Be sure to cover all exposed pipe ends, use tape when necessary, and ensure that the insulation is not damaged or pinched by supporting hardware.

Fresh Water System Installation:

The chiller unit is typically installed in the engine room. Ensure the unit is mounted on a solid, horizontal surface capable of supporting its weight, especially when the boat is in motion. Choose a dry location that allows for easy servicing. Maintain at least 0.9 to 1.2 meters of clearance around the unit, with a minimum of 0.9 meters of vertical space above it for proper ventilation and accessibility.

Plumbing System:

The plumbing system is often the root cause of common issues in chilled water systems, so it is essential to give special attention to this section.

Automatic Fill and Bleeders:

If your plumbing system includes automatic bleeders, ensure an automatic fill system is also installed in the chilled water loop. Low water pressure can lead to pump cavitation, which shortens the pump's lifespan. The automatic fill valves should maintain the pump's inlet pressure between 0.7 and 1.0 bar and must include back flow prevention valves. Monitor the glycol concentration carefully when using an automatic fill system to avoid freezing and ensure smooth operation.

Pipe Installation:

Secure all piping using the correct fittings, and provide adequate support by attaching the piping to the boat's structure. Ensure that pipe insulation is not pinched by any supporting hardware, and verify that all connections and hose clamps are properly tightened and secure.

Service Valves:

Install service valves to facilitate future maintenance of the system. Only use full-flow ball valves. Unions or flanges may also be added, but it is important to leak-test them after installation.

Flow Rate:

The flow rate of the chilled water system is critical to the proper functioning of the chiller. Refer to the system's specifications to ensure the flow rate is within the required range.

For further questions or concerns regarding the installation or operation of your MBC Marine Variable Chiller System, please consult our Technical Service team.

INSTALLATION GUIDELINES FOR FRESH WATER SYSTEM

PREVENTING AIR AND WATER TRAPS

Typically, the circulating pump should be located at the lowest point in the water loop, followed by the chiller, and then the air handlers at the highest point. The ideal setup minimizes vertical direction changes, with air handlers containing built-in vents to bleed trapped air.

To avoid creating air or water traps, the piping should follow a consistent upward or downward slope. Any vertical reversal in the piping can create air or water traps, which may cause noise and hinder water flow. Additionally, such traps make it difficult to fill, bleed, or drain the system. To prevent air from getting trapped, vent valves (or “bleeders”) should be installed wherever an air trap might form. For maximum effectiveness, the air handlers should be installed at the highest point in the system. If auto bleeders are used, they must be positioned above the air handlers. Water traps can prevent the complete draining of the system during maintenance or winterizing, so it’s essential to install a drain at the lowest point of any water trap.

AIR BLEEDERS

It is essential to have a way to release trapped air from the system. All MBC air handlers and chillers are equipped with bleeder valves. In addition to these, a main bleeder should be installed at the highest point of the system and routed to a valve with a discharge in the engine room. This setup allows for easy filling and venting of the system simultaneously. Additionally, localized high points may require their own bleeder valves.

WATER FLOW DIRECTION

Pay close attention to the arrows on the unit indicating the direction of water flow. Reversing the flow can lead to various issues, such as malfunctioning of the flow switch. For most chillers, chilled water should enter via the upper copper connection and exit through the lower copper connection. In contrast, seawater enters at the lower port and exits through the upper port.

RETURN ABOVE SUPPLY

Always position the chilled water return lines (returning water to the chiller) above the supply lines (water flowing from the chiller). This arrangement allows air in the system to naturally rise and flow with the water.

CIRCULATION PUMP POSITION

The circulating pump should be installed as low as possible in the water loop. The chiller should be positioned above the pump, and the air handlers should be installed at the highest point.



IMPORTANT WARNING:

Do not operate the system without a water strainer! Running the system without a water strainer will cause the water pump to fail, which may lead to the complete failure of the system. Replace the plastic water strainer casing every 2 years. The water system must have the ability to be shut down in the event of a malfunction or for maintenance. Operating the system without a ball valve can be life-threatening.

STRAINER REQUIREMENTS

Strainers are essential in both the condenser/seawater circuit and the circulated water circuit. Failing to adhere to these guidelines will void the warranty.

The circulated water circuit should use a 20-mesh “Y-strainer”, while the seawater circuit should utilize a 10-mesh strainer. While finer meshes may provide better filtration, they will require more frequent cleaning, which can become inconvenient. More open meshes must not be used, as they will not adequately protect system components.

Strainers must be serviceable and include an arrow indicating the correct direction of water flow. The arrow should follow the flow direction and may point horizontally or downwards, but never upwards. If installed horizontally, the basket should always be positioned below the pipe, never above.

The strainer must be installed upstream of the chiller to protect the heat exchanger from debris. Typically, the strainer is placed just before the pump, with the pump located upstream of the chiller. While it is acceptable to position the pump before the strainer, this is not recommended. There must be no air handlers between the strainer and the chillers.

Pressure gauges should be installed on both sides of the strainer to easily monitor when it requires cleaning. (Refer to the section on pressure gauges for further details.)

Ball valves should also be installed before and after the strainer, allowing for easy cleaning without excessive water loss.

CLEANLINESS

Strainers are not designed to catch fine particles, so it is crucial that the system is assembled using clean pipes and components. Failure to do so can result in dirt and debris accumulating in the evaporators, leading to system failure. **Frozen evaporators clogged with mud or debris are not covered under warranty!**

The key to preventing this is maintaining proper cleanliness. Thoroughly inspect pipes and components for cleanliness before installation. If any parts are dirty, clean them. Pipes that are stored should have their ends sealed to prevent dirt and debris from entering. Even a small amount of dirt, once spread throughout the system, can accumulate at the bottom of an evaporator and cause major problems.

While a mud separator can offer extra protection, it is unnecessary if the system is assembled with clean components and filled with clean water.

PIPE SIZE

The recommended pipe size should be based on the total water flow requirements to maintain stable pressure. Overly large pipes can be harmful and may lead to drastic changes in water velocity.

The pipe sizes recommended in Table 1 are designed to minimize pressure losses. However, the next larger pipe size should be considered if the capacity being served is near the upper limit of the range and any of the following conditions apply:

The pipe run includes numerous bends.

Exceptionally long distance.

There is potential for additional capacity in the future.

TABLE 1

Pipe Size (ID)	Capacity Range (BTU/hr x 1000)
3/4"	4 - 21
1"	24 - 45
1-1/4"	48 - 81
1-1/2"	84 - 129

It's important to note that significantly over-sizing pipes can also be detrimental. Sudden changes in water velocity can result in increased losses and noise within the system.

To determine the appropriate pipe size, add the total BTU rating of the air handlers served by the pipe. Chillers are typically sized to about 80% of the total air handler load, though smaller vessels may use a higher percentage, while larger vessels can often use a lower percentage.

The hose connecting to an air handler should match the hose barb provided with the unit. The ball valve for air handlers up to 24K BTU should be a 3/4" full port valve, while air handlers rated 30-36K BTU should use a 1" full port valve.

DROP WATER DRAIN

The unit produces condensate that collects in the drain pan. Choose the location of the air handler so that condensate drainage is always possible. The water collected in the drain pan must be routed through the drain discharge line to the boat's bilge, ideally near the automatic bilge pump.

If the air handler is installed in a location where direct drainage to the bilge is not possible, the water must be collected and pumped out. When installing a drain pump, ensure that the drain pump's outlet is not combined with the outlets of other systems.

INSULATION OF CIRCULATION SYSTEM

Pipe Insulation:

Insulate the straight sections of piping before conducting a leak test. Once the system passes the test, proceed to insulate the joints and fittings.

Insulation Material:

Use closed-cell insulation with a minimum thickness of 1.9 cm. In non-air-conditioned areas, thicker insulation may be required.

Supply and Return Pipes:

Both the supply and return water pipes should be insulated and clearly labeled to differentiate them.

Thorough Insulation:

Ensure all pipes are properly insulated. Condensation is a common is-

sue in chilled water systems and can go unnoticed until water damage occurs. Cover all exposed ends, use tape for split-insulating, and ensure the insulation is not compressed or damaged by supporting hardware.

Use pump enclosures: Enclosing the pumps can further reduce the risk of condensation by providing an extra layer between the pump and the ambient air, which reduces the temperature differential.

FRESH WATER CIRCULATION

Pump Location, Pipe Length and Pressure Loss:

It is important to install the pump as close as possible to the chiller unit to minimize pipe length and reduce pressure loss. This ensures optimal water flow throughout the system.

Pump Size and Capacity: The pump should be sized based on the required flow rate and the pressure loss in the piping system to ensure efficient water circulation to all parts of the system.

Maintenance Access: The pump should be easily accessible for regular maintenance. Its location should allow for easy cleaning and inspection to keep the system in good working condition.

Vibration and Noise Reduction: Consider using flexible mounting solutions to reduce vibrations and noise from the pump during operation, enhancing overall comfort on the vessel.

Air Trap Prevention:

The pump discharge should be positioned vertically upward to prevent air from being trapped in the pump head, with a straight vertical pipe run leaving the pump.

Pipe Alignment:

Pipes connected to both the pump inlet and discharge should be straight for at least 30 cm to ensure a uniform water flow.

Vibration Isolation:

Use vibration isolation mounts to prevent vibrations from transferring to the boat's structure.

Service Valves:

Service valves should be installed at the pipe fittings connected to the pump to facilitate pump maintenance and removal.

Pressure Gauges:

A pressure gauge must be installed at the pump inlet, positioned for easy visibility when operating the fill valve. It is also recommended to install a pressure gauge at the pump discharge to assist in system filling and diagnosing flow restrictions.

Pressure Ports:

Install pressure ports immediately upstream and downstream of the circulating pump. These ports allow you to calculate the pump flow by comparing the pressure difference with the pump's performance curve.

Two-Pump System:

The two-pump system ensures efficient water circulation throughout the cooling system, significantly improving both performance and reliability.

One pump is responsible for circulating water to the air handler units, while the second pump manages water flow to the chiller units. A balancing pipe connects the two pumps, allowing them to function in harmony without the need for additional flow control devices.

In the event of a pump failure, a full-flow valve in the balancing pipe allows the remaining pump to supply the entire system, ensuring partial operation is maintained.

This configuration is particularly crucial for larger, multi-zone cooling systems, where optimal efficiency and reliability are key to effective operation.

Flow Control Valve:

Each MBC Air Handler is equipped with its own flow control valve. If the air handler's capacity exceeds 10% of the chiller's capacity, a bypass around the flow control valve may be necessary if the pump cannot force enough liquid through the chiller.

Chiller Capacity Adjustment:

If the chiller's capacity is more than 10% greater than the air handler's capacity, a bypass flow control may be required to balance the system and maintain proper liquid flow through the chiller.

Combined Heating and Cooling:

MBC fan coil units are equipped with an electric heating element, providing a combined heating and cooling solution. This is particularly useful in locations with varying temperature needs. These units consist of a fan-assisted heat exchanger and a built-in electric heater.

Expansion Tank:

The expansion tank should be connected to the inlet side of the circulating pump.

It is advisable to install a service valve at the expansion tank to facilitate future maintenance.

While the expansion tank can function in any position, it must not place stress on the pipe connection. Therefore, it is typically best to mount the tank vertically. Avoid installing the expansion tank (and its service valve) in a way that its weight creates leverage, putting strain on the pipe or its connection.

FILLING THE FRESHWATER CIRCUIT OF THE CHILLER SYSTEM

Proper filling of the freshwater circuit in the chiller system is essential for the system's efficient operation and long-term reliability. The following steps ensure that the system is properly filled, vented, and free from debris and air.

1. Use of Clean Water:

Always use clean, potable water to fill the freshwater circuit. Ideally, the water should be warm, as warm water dissolves less air, helping to reduce the risk of airlocks in the system.

2. Preparation and Inspection:

Before beginning the filling process, inspect the system to ensure all components are properly connected and there are no leaks. Check the main air vent, usually located at the highest point in the system. If there is no main air vent, use the air vent on the highest air handler unit.

3. The Filling Process:

A. Initial Steps:

Open the main air vent, or if there isn't one, use the air vent on the highest air handler.

Open the fill valve and allow water to enter the system until water flows through the vent pipe without any air bubbles.

Close the air vent once the air has been released and only clean water is flowing.

B. Pressure Build-Up:

Allow the static pressure to build up until it reaches approximately **1.4 bar**.

Close the fill valve(s) once the pressure has reached this level.

C. Venting:

Begin venting the chiller and each air handler, starting from the lowest point and moving upwards.

If the pressure drops significantly during the venting process, more water will need to be added to maintain proper pressure.

After the initial venting is complete, open the fill valve again and refill the system to **1.4 bar**.

4. Pressure Test:

It is recommended to perform a **pressure test** after filling the system but before filling it with glycol to check for leaks.

During the pressure test, monitor the stability of the pressure. If the pressure drops, it may indicate a leak, which must be repaired immediately.

5. Second Venting:

After the system has been running for a while, turn it off and allow the water to settle.

Repeat the venting process, starting from the lowest point and moving upwards, to remove any remaining air from the system.

6. Temperature Setting and Testing:

Turn on the chiller system and adjust the cabin temperature controls. Ensure the circulation pump starts immediately, and the system reaches the desired temperature.

7. Cleaning the Strainer Basket:

During and after the filling process, regularly clean the **strainer basket** to remove any debris or particles that may have remained in the system after flushing.

8. Final Inspection:

After the system is operational, monitor the condition of the cooling water. The water should be clear and free of air bubbles, and there should be no air in the system, which could reduce efficiency.

Summary:

Filling and venting the freshwater circuit of the chiller system requires careful attention to ensure the complete removal of air and debris. A properly filled and vented system ensures efficient cooling system performance, prevents problems caused by airlocks, and helps to maintain long-term reliability.

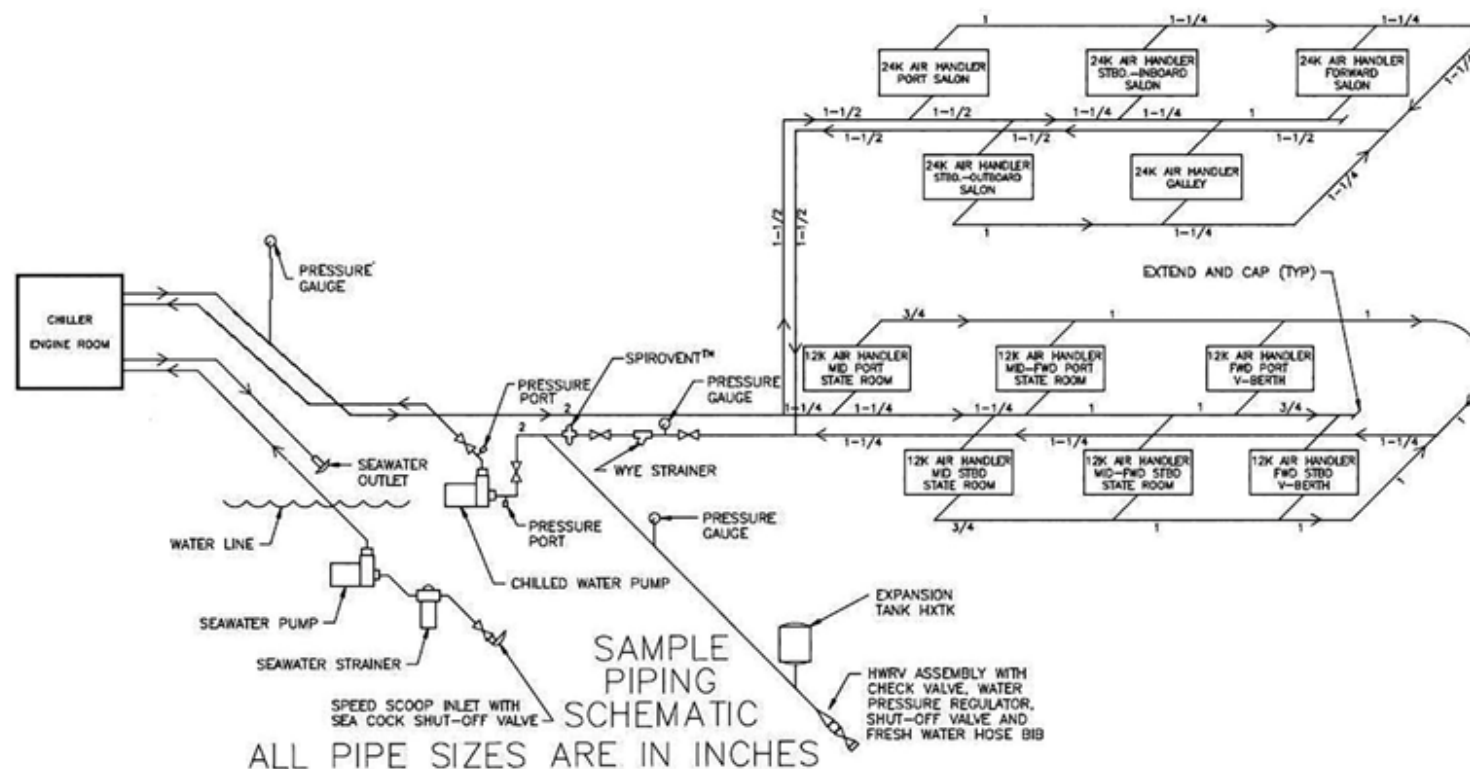

INSTALLATION GUIDELINES FOR AIR HANDLER UNIT

MBC fan coil units feature an integrated electric heating element, providing a dual heating and cooling solution that is highly efficient in areas with fluctuating temperature demands. These units include a fan-powered heat exchanger along with a built-in electric heater, offering an additional boost in heating capacity when necessary.

Ducting and Airflow

For optimal system performance, the ducting must be installed as straight and smooth as possible. Avoid excessive bends or loops that could restrict airflow. Secure the ducting to prevent movement during operation, but take care to avoid compressing or pinching it, as this can reduce airflow.

Before installation (if necessary) set the fan in the direction which allows the most direct airflow through the air pipes. The air outlet direction of the unit's fan can be adjusted horizontally or vertically. Adjust the air outlet position by loosening the fixing screw and tightly fasten the fixing screw after positioning the outlet to the optimum position.



WARNING!

Systems are sensitive to air reductions, (e.g. from 150mm to 100mm) which result reduction of air flow efficiency.

During installation, avoid 90°-180° curves on the air duct because the bends are reduce the airflow by 25%)



WARNING!

The air outlet must not be directed towards the air intake as short circulating cycles can lead to a loss of performance!

MOUNTING THE AIR HANDLER AND THE ELECTRICAL BOX

Air Handler Placement:

The Air Handler Unit should be installed as low as possible (e.g., under a V-berth or at the bottom of a locker), while the supply air duct should be positioned as high as possible. This setup promotes optimal air circulation and helps prevent short cycling of the system.

Positioning the Air Handler:

Mount the unit directly behind the return air grill. If the air handler is placed near a bulkhead or other obstructions, ensure at least 76mm of clearance for proper air circulation.

Electrical Box Installation:

The electrical box for the Air Handler, which contains the start capacitor for the blower fan, should be installed remotely on a bulkhead or a sturdy frame.

Vibration Reduction:

Use the included non-slip isolator tape to reduce vibrations caused by the operating unit. Securely apply the tape to the base of the air handler.

Mounting Brackets:

Four mounting brackets are provided and should be spaced evenly around the edge of the drain pan. Use these brackets to secure the air handler to a flat, level surface. The necessary hardware, such as screws, bolts, and washers, must be supplied by the customer.

Blower Adjustment:

If needed, loosen the lock screw on the blower to adjust its position for the most direct airflow. Once the blower is in the optimal position, securely tighten the screw.

Note that the air handling units are not electrically connected to the chiller or panel control.

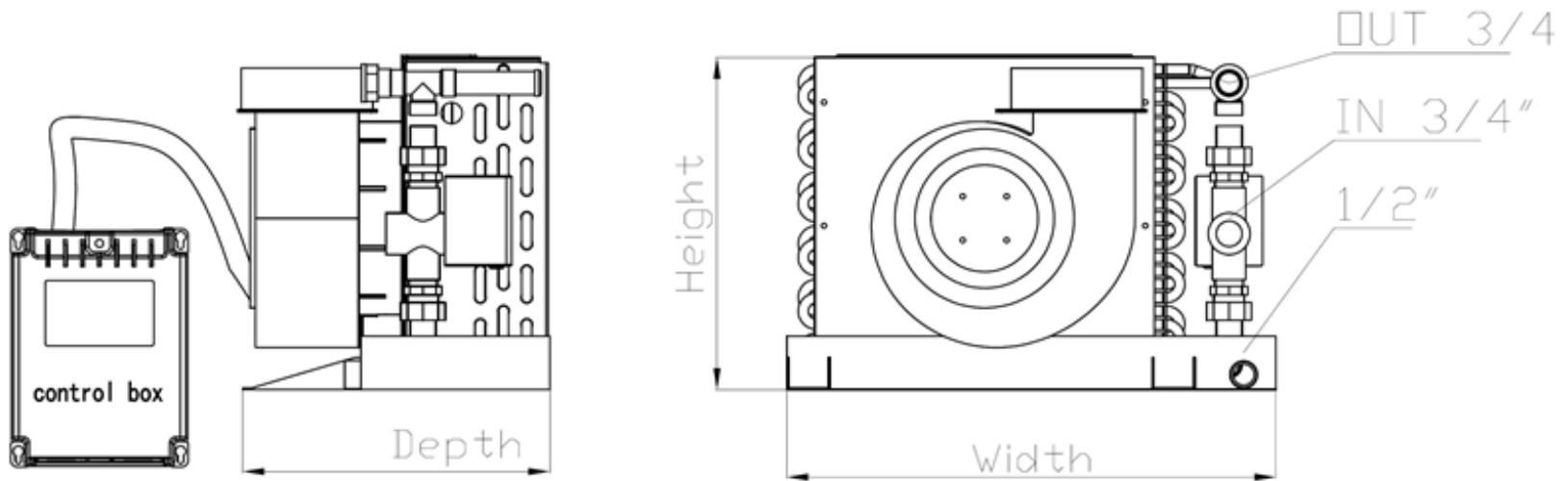

UNIT PARAMETERS		CFPG08	CFPG10	CFPG12	CFPG16	CFPG24
Cooling capacity	BTU/hr	8000	10000	12000	16000	24000
Power source		230V/50Hz				
Operating Current	A	0,4 A	0,5 A	0,8 A	0,9 A	1,1 A
Input power	W	100 W	120 W	150 W	200 W	220 W
Sea Water Connection size		1/2"	1/2"	1/2"	1/2"	1"
Drain Water Connection size		DN15	DN15	DN15	DN20	DN20
Chilled Water Flow	L/min	6,5 L/min	9,5 L/min	11,5 L/min	16,5 L/min	23,5 L/min
Chilled Water Connection Size		3/4"	3/4"	1"	1"	1"
Dimension of Unit	Width	380	440	440	500	560
	Height	261	310	310	355	430
	Depth	277	318	318	346	373
Net Weight (kg)		8,5 kg	10,5 kg	11,6 kg	15,5 kg	21 kg

SEAWATER SYSTEM INSTALLATION INSTRUCTIONS

Water Intake Placement:

Install the water intake fitting as deep and as close to the keel as possible to ensure proper water flow. Ensure the water intake fitting is easily accessible. Use the correct drill size when drilling the hull to avoid damaging the material.

Through-Hull Fitting Installation:

A separate inlet fitting and seacock must always be used for the air conditioning seawater pump. Careful consideration must be given to the location of the inlet fitting. The dedicated through-hull for the air conditioning system should be positioned within 15 cm of the keel and ahead of the engine intake fitting.

Do not attempt to pull seawater from the engine or generator intake. For most installations, especially on faster vessels, a scoop-type inlet is recommended. This fitting should face forward and be located near the keel or centerline to ensure it remains submerged while the air conditioner is running. Be mindful of how the boat's motion can affect the fitting's position relative to the waterline.

In sailboats, special attention is needed due to the steep heel angles they may experience, which can cause the through-hull fitting to rise above the water, resulting in an air lock in the pump. Seal the water inlet with a **marine-grade sealant** suitable for underwater use, and always follow the manufacturer's instructions for the sealant.

Ball Valve Installation:

Install a ball valve to the water inlet fitting and secure the bronze hose connector to the valve. The use of a ball valve in the seawater system is mandatory for safely shutting off the water flow when necessary. Failure to install a ball valve can be life-threatening and poses significant safety risks.

Water Strainer Positioning:

Place the water strainer in a location that allows easy access for cleaning. Ensure that the flow direction aligns with the markings on the water strainer.

Connecting the Water Pipes:

Connect the water pipe from the water intake fitting to the water strainer.

Next, connect a pipe from the water strainer to the pump, and from the pump to the lower condenser input (marked with an arrow) on the marine A/C unit.

Finally, connect the water pipe from the condenser outlet to the water outlet fitting.

Electrical Wiring:

The only wires to be connected to the pump are the power wires from the output of the pump relay or control panel. Pay close attention to the wiring schematic label located on the side of the pump motor.

Determine the correct supply voltage, and connect the pump accordingly. Incorrect wiring can result in motor damage.

Ensure that the pump is rotating in the proper direction, typically indicated by an arrow on the pump head. All field wiring should be performed by qualified personnel, and the correct wire size and proper terminals must always be used.

Sea water Pump Relay

By using a Pump Relay Box, you can efficiently manage multiple air conditioning units.

This Relay Box guarantees that the pump only operates when any of the connected air conditioning units are running.

Make sure the selected pump is capable of handling the combined seawater flow requirements of all air conditioning units. Refer to the system specifications for the flow rate requirements of each unit.

Sacrificial Anode:

It is recommended to install a **sacrificial anode** (zinc or aluminum) upstream of the seawater pump to protect the system, particularly the condenser, from corrosion. **MBC Marine assumes no liability** for any damage caused by electrolysis or corrosion if no sacrificial anode is installed in the system.

Pump Installation:

The seawater pump should be installed **below the waterline** and positioned close to the chiller unit. The centrifugal pump is not self-priming, so it requires a **free flow of water**. Air in the seawater system can lead to air locking, particularly in sailboats when heeling, so special measures may be needed to prevent this.

The pump head must always discharge **upward**, with a straight vertical pipe leaving the pump. This setup helps prevent air from becoming trapped in the pump head, a common issue that can disrupt water flow and damage the pump.

Ensure the pump is securely bolted to a **horizontal surface**, with the discharge connection positioned as the highest point. Use **resilient mounts** to minimize vibrations being transferred to the boat's structure. The pump should be easily accessible for maintenance, in a location where it won't be stepped on or struck by moving machinery.

The pipe leading to the pump's inlet should be **straight for at least 30 cm**, ensuring a uniform flow of water into the pump. Do not install check valves in the seawater system, as this can cause air locking if any air enters the system. **Running the pump dry** will lead to partial or complete failure.

Bends and Loops on Pipe System:

During water pipe installation, avoid sharp bends, loops, and 90° angles, which can restrict water flow and create pressure losses. Where changes in direction are necessary, use smooth curves or **45° fittings** to minimize disruption to the water flow.

Thread Sealing:

Use **thread sealing cord** (e.g., Loctite 55) or an approved **pipe thread sealant** for all metal-threaded connections to ensure a watertight seal and prevent corrosion in the threaded joints. Avoid using Teflon tape, as it may not provide the same level of sealing for metal threads in marine environments.

Grounding Metal Parts:

Connect a **grounding wire** to all metal parts that come into contact with seawater, including the seawater inlet, pump, and air conditioning unit. This is essential to prevent electrolysis and corrosion caused by stray electrical currents. The grounding wire should be connected to the boat's **common grounding system** to ensure protection.

Leak Check:

Once the installation is complete and the boat is placed in the water, carefully inspect all fittings, connectors, and seals for any signs of leakage. Pay special attention to the areas around the pump, water inlet, and air conditioning unit, as leaks in these areas can lead to significant water damage over time.

Grounding Reminder:

Note: All metal components that come into contact with seawater **must be connected** to the boat's grounding system. These components include:

- The water inlet fitting
- The pump (via the ground wiring harness)
- The air conditioning unit

Proper grounding will help prevent damage caused by electrolysis and prolong the life of the components.

Final Check:

Before starting the unit, carefully inspect the entire water system for leaks. Ensure all connections are tight and secure, and that no water is seeping from any joints. Conduct a pressure test if possible to ensure the system can handle the expected water pressure without leaking.

Extreme seawater temperatures can impact Marine A/C performance.

In **cooling mode**, optimal efficiency is achieved when seawater temperatures are below **27°C**. As the water temperature rises above this point, the system's cooling capacity gradually decreases. However, it will still provide cooling at seawater temperatures up to **40°C**, though with significantly reduced efficiency.

In **heating mode**, the opposite occurs. As seawater temperatures drop below **13°C**, the heating capacity diminishes. Nonetheless, the unit can continue to produce heat at seawater temperatures as low as **7°C**, albeit with reduced efficiency.

Note: The system must not be operated at seawater temperatures below 7°C.

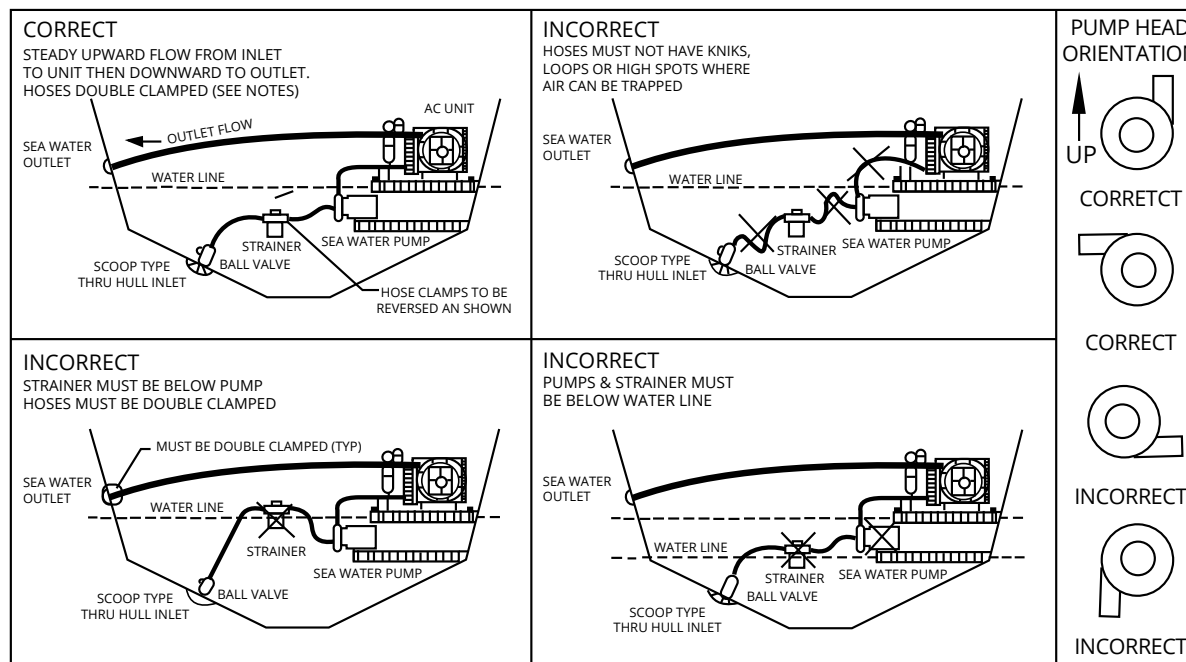

Follow the guidelines below to properly install the water system of the marine air conditioner unit. See pictures below:

BEFORE THE FIRST START

As a condition of the warranty, the installer is required to provide clean circulating water in the system. If this is not done, dirt can accumulate in the evaporators, causing them to freeze and rupture. Additionally, dirt can clog the air handler valves and other components, which may damage these elements.

Therefore, it is crucial that the system operates with clean water to avoid malfunctions and damage to the system.

Highly recommend to make a leak test the fresh water plumbing throughout the installation of the system, as well as after the installation is complete. This is especially important when joints will be concealed and therefore very difficult to get to in case of a leak.

A simple procedure of pressurizing the pipes with air will indicate whether that section of plumbing is sound. The piping system should be able to hold 5 bar over a 12 hour period (minimum).

It is very important to use **clean components** during assembly. However, the assembly process itself can introduce debris into the system, such as remnants of thread-sealing tape or pipe sealant. Therefore, it is recommended to thoroughly **flush the system** before the initial filling.

Do not operate or allow water to enter the chiller or air handlers until the circulated water system has been thoroughly flushed. The best method to ensure clean, debris-free circulation is to flush the en-

tire internal chiller system with clean water before the first glycol fill. Observe the water during the draining process by collecting a small amount in a bucket for inspection.

It is recommended to perform a **pressure test** after flushing and before filling with glycol to ensure the system is leak-free. During the process, clean the strainer basket until no debris remains.

Before use, the cooling water must be **clear and free of air bubbles**.

MAINTENANCE

To ensure optimal performance and longevity of the cooling system, it is recommended to create an air conditioning system maintenance log. This log will help you track all activities starting from the system's initial start-up. Make sure that all maintenance operations are recorded in detail.

DAILY

Seawater Filter

- Check the seawater filter daily.
- Inspect the filter for debris and remove any accumulated materials, such as seaweed, shells, or other obstructions.
- Important: Never run the seawater pump while the filter is removed, even for a short time. If debris such as shells or other obstructions are picked up by the pump, they can become lodged in the condenser, potentially causing system failure.

MONTHLY

Air Filters

- Dirty filters reduce airflow and system performance. Check the dust filter or the filter behind the return air grille, or at the front of the air handler, at least once a month. Replace or clean the filter if necessary.

Run the System

- It is recommended to operate the cooling systems regularly. Refrigerators and air conditioners on ships that are not in use should be turned on for 30-60 minutes once a month.
- Additionally, the systems should be switched to reverse mode

(from cooling to heating or from heating to cooling). This helps preserve pump seals and internal mechanical components, while also reducing marine growth fouling in the seawater circuit.

THREE MONTHS

Fresh Water System Pressure

- Check the pressure at the pump inlet while the water is cold, the air handlers are off, and the circulation pump is running. If the system pressure drops below the normal level, additional water must be added.
- When opening the air handler vent, water or air should be expelled.
- Be cautious not to overfill the system, as this can prevent the expansion tank from functioning properly.
- If the system pressure frequently drops, it is likely that a leak needs to be identified and repaired.

Condensation Drainage

Check that the condensate drains from the air handler and refrigerator are not blocked by pouring a few liters of water into the air handler unit pan. If the water does not drain completely within 30 seconds, ensure that the drain holes are not obstructed.

Note that the system has two drains, one at each end of the unit.

Electrical Connections

Electrical connections should be inspected and tightened as necessary. Heat and vibration can cause connectors to loosen, leading to poor contact, voltage drops, or arcing, which can result in component malfunction, loosening, or premature failure. When servicing electrical components:

- Disconnect power before repairing or replacing parts or wiring.
- Tighten any loose connections at the terminal strip and components.
- Inspect connectors for burn marks, frayed wires, or other damage. If issues are found, the connector or connection should be repaired or replaced.
- To ensure adequate power supply, regularly measure the voltage of the equipment.

SEAWATER CONNECTIONS

Verify that all seawater connections are tight, and check for water flow from the overboard discharge.

YEARLY

REFRIGERANT

The MBC Marine variable chiller unit is pre-charged with refrigerant gas at the factory and is adequate for the life of the system. Routine “seasonal” charging of the system is not necessary. If the refrigerant charge is low, there is a leak which should be fixed before resuming operation.

Proper winterization of the chiller units is essential to protect the system from freezing and ensure a long service life. Follow the steps below to correctly winterize the system before cold weather arrives:

Drain the Fresh Water System:

- Open all valves, including the lowest drain points, to completely drain the fresh water from the system. Pay particular attention to areas where water might collect. Winterization of the fresh water system is only necessary if the system is not filled with glycol (a common antifreeze solution).

Drain the Seawater System:

- Open the valve lock and any drain connections in the seawater circuit. Ensure that all water is drained from the seawater pump, heat exchanger, and piping.

Flushing the System:

- Fresh Water Circuit: After draining, flush the fresh water circuit with clean water to remove any residual dirt or contaminants.
- Seawater Circuit: Similarly, flush the seawater circuit with clean water to remove salt, dirt, and debris that could cause corrosion or blockages.

Dosage of Antifreeze:

- Choose the Right Antifreeze: Use a non-toxic, propylene glycol-based antifreeze that is safe for marine environments. The antifreeze must be suitable for the lowest expected winter temperatures.

Protection of the Seawater Side:

- Application of Antifreeze: If the chiller system operates in an area where seawater may freeze, consider introducing antifreeze into the seawater side as well, especially if there is a risk of freezing.
- Seawater System: Alternatively, you can completely drain the seawater circuit and ensure there is no water left in the pump, heat exchanger, or pipes. Keep the valve closed to prevent water from flowing back into the system.

Inspection of Insulation:

- Check Insulation: Ensure that all piping, especially parts exposed to cold air, are properly insulated to prevent freezing. Repair or replace any damaged insulation.
- Pump Covers: If pumps are exposed to cold temperatures, consider covering them or adding additional insulation to prevent freezing.

Final Check of the System:

- Depressurization: Make sure the system is completely depressurized before closing and winterizing the chiller. Ensure all valves are closed and there is no water remaining in low points of the system.
- Visual Inspection: Conduct a final inspection of all system components, including the chiller, pumps, and piping, to ensure no water remains in areas where it could freeze.

PUMPS

Remove oil, dust, dirt, water, and chemicals from the exterior of the motor and pump. Ensure that the air inlet and outlet openings of the motor are unobstructed. Blow out the interior of open motors using clean, low-pressure compressed air. Inspect the pump housing and impeller cover for excessive wear. Worn or damaged impellers reduce water flow and should be replaced. Excessively worn or corroded housings can cause leaks. Any signs of corrosion should be treated immediately.

AIR HANDLING VALVES

The air handling motor water valves should be inspected for corrosion that could impede the gear mechanism.

- All bleeder valves should be checked regularly and replaced if necessary.
- With the air handler turned off, open the water valve and remove the motor housing. Inspect the gears and clean off any deposits from the motor gear and/or valve gear.
- Thoroughly dry all parts and coat them with silicone spray or an equivalent product.
- Before reassembling, manually test the actuator by using the lever on top of the valve.

SENSORS

All control probes and sensors should be checked to ensure they are in the correct position and properly secured. Improperly positioned or loose probes can lead to inaccurate readings and system failures.

- Check all temperature probes and sensors on the chilled water unit.
- Probes inserted into the circulating circuit must be fully inserted into the well, filled with thermal paste for efficient heat transfer, and the end should be insulated to hold the probe in place and prevent condensation.
- Externally attached probes on coils, tubes, etc., should be securely fastened with hot glue between the contact surfaces, and insulated if necessary, for accurate readings.
- Inspect the location of all sensors on the air handlers. Water sensors should be securely fixed and insulated on the water inlet of the air handler. If you are not using the built-in air sensor on the controller display panel, remote air sensors in the return air stream should be placed as close to the cabin area as possible, avoiding contact with hot or cold surfaces.
- All sensors must be securely attached.

CLEAN SEA WATER CIRCULATION

Condenser coils and seawater lines located below the waterline can become fouled over time due to marine growth and deposits within the coils. This obstructs water flow and prevents proper heat transfer, causing the compressor to operate continuously at high pressure, temperature, and current. Condenser coils and seawater hoses can be flushed and cleaned by connecting a closed-loop system and circulating a descaling solution.

TROUBLESHOOTING

The PCB controller will display if there is any error during the system operation. Please follow the troubleshooting guidelines below. The troubleshooting and error codes are grouped into four categories: unit-resumed protection, system-resumed protection, serious unit fault, and serious system fault.

Code	Meaning	Description	Possible Consequences	Solution
E1:01	Freshwater Return Water Temperature Sensor Malfunction	The freshwater return temperature sensor has malfunctioned. This sensor measures the temperature of the returning freshwater in the system. If the sensor fails, the system cannot accurately monitor the return water temperature.	<ul style="list-style-type: none"> The system may not regulate the temperature properly, leading to excessive cooling or heating. Equipment efficiency may decrease as the system does not account for the return water temperature during regulation. An error code will appear on the control panel, indicating the sensor malfunction. 	The sensor must be replaced to restore accurate monitoring of the return water temperature. After replacing the sensor, the system needs to be restarted to clear the error code and verify proper operation of the temperature sensors.
E1:02	Freshwater Forward Temperature Sensor Malfunction	This sensor measures the temperature of the freshwater before it enters the cooling system or heat exchanger. The sensor is crucial for maintaining the correct temperature, as it helps the system optimize the cooling or heating process. If this sensor malfunctions, the system cannot accurately measure the inlet water temperature, which may lead to improper cooling or heating.	<ul style="list-style-type: none"> The system may overheat or undercool, as it cannot properly monitor the inlet water temperature. Equipment energy efficiency may decrease, as the system operates at non-optimal temperatures. An error code will appear on the control panel, alerting the operator to the sensor malfunction. 	Replacing the sensor is essential to restore accurate inlet water temperature monitoring. After replacement, the system needs to be restarted, and the sensors should be checked for proper operation. The error code will clear once the new sensor is functioning properly.
E1:03	Seawater Return Temperature Sensor Malfunction	This sensor measures the temperature of the seawater as it exits the system. Accurate temperature measurement ensures that the system operates within the desired temperature range, avoiding overheating or reduced efficiency.	<ul style="list-style-type: none"> The system may overheat if it cannot properly monitor the seawater return temperature, potentially causing long-term damage to the equipment. Cooling efficiency may decrease as the system lacks proper data on the return seawater temperature, affecting the condenser unit's performance. An error code will appear on the control panel, alerting the operator of the sensor malfunction. 	The sensor must be replaced to restore proper system operation. After replacement, the system needs to be restarted, and the temperature sensors should be checked for accurate readings. The error code will automatically clear once the system returns to normal operation.

Code	Meaning	Description	Possible Consequences	Solution
E1:04	Seawater Forward Temperature Sensor Malfunction	This sensor measures the seawater temperature before it enters the heat exchanger. Accurate temperature measurement is key to ensuring that the heat exchanger operates at optimal temperatures and that the cooling system performs efficient heat exchange. If this sensor malfunctions, the system cannot accurately determine the seawater temperature, negatively affecting heat exchanger performance.	<ul style="list-style-type: none"> The heat exchanger may not regulate the temperature properly, leading to decreased system efficiency. The cooling system may overheat or fail to reach the desired temperature, disrupting the cooling cycle. An error code will appear on the control panel, indicating the sensor malfunction and the need for maintenance. 	The sensor must be replaced to restore accurate seawater temperature measurement. After replacement, the system needs to be restarted to ensure that the new sensor functions properly. The error code will disappear once the sensor operates normally, and the system returns to optimal heat exchange performance.
E1:05	Compressor Forward Temperature Sensor Malfunction	This sensor monitors the temperature of the refrigerant as it exits the compressor. Accurate refrigerant temperature measurement is essential for proper compressor operation, ensuring that the system works within the correct temperature range and prevents overheating or improper cooling cycles.	<ul style="list-style-type: none"> If this sensor fails, the system cannot monitor the refrigerant temperature exiting the compressor, leading to potential overheating. The system may operate inefficiently, unable to regulate refrigerant temperature, reducing cooling performance. An error code will appear on the control panel, indicating sensor failure and the need for maintenance. 	Replacing the sensor is necessary to restore accurate monitoring of the refrigerant temperature exiting the compressor. After replacing the sensor, the system should be restarted and checked to ensure proper sensor operation. The error code will clear once the system is functioning correctly, and the compressor returns to optimal performance.
E1:06	Compressor Return Gas Temperature Sensor Malfunction	This sensor measures the temperature of the refrigerant before it returns to the compressor. Proper temperature monitoring is critical for efficient compressor operation, as it helps maintain an optimal cooling cycle and ensures that the compressor operates without overheating or becoming overloaded.	<ul style="list-style-type: none"> The compressor may overheat if the system cannot accurately measure the return refrigerant temperature, potentially leading to long-term system failure. The system may not regulate effectively, resulting in reduced cooling performance and increased energy consumption. An error code will appear on the control panel, alerting the operator to the sensor malfunction and indicating the need for maintenance. 	Replacing the sensor is essential for accurate monitoring of the return refrigerant temperature. After the sensor is replaced, the system should be restarted to ensure proper operation of the temperature sensors. The error code will clear once the new sensor is functioning, and the compressor returns to optimal operation.
E1:07	Low Pressure Sensor Malfunction	The system's low-pressure sensor is malfunctioning or has failed. This sensor measures the refrigerant pressure on the compressor's suction side and ensures the pressure is at the desired level for proper operation. The low-pressure sensor is crucial for monitoring system pressure to prevent compressor overload or reduced cooling efficiency.	<ul style="list-style-type: none"> If the sensor fails, the system cannot monitor refrigerant pressure, potentially leading to compressor overload and damage. System performance may decrease as the refrigerant pressure cannot be properly regulated, leading to faulty cooling cycles and reduced efficiency. An error code will appear on the control panel, alerting the operator of the sensor failure and indicating maintenance is needed. 	The low-pressure sensor must be replaced to restore proper pressure monitoring. After replacement, the system should be restarted, and refrigerant pressure should be checked to ensure it is at the desired level. The error code will automatically clear once the system operates correctly and the pressure is within the appropriate range.

Code	Meaning	Description	Possible Causes	Possible Consequences	Solution
E1:08	Insufficient Freshwater/Glycol Flow	The flow of freshwater or glycol in the system is insufficient. Proper flow is critical for the efficient operation of the cooling or heating cycle, as it ensures that the refrigerant can transport thermal energy between different units. If the flow is inadequate, system performance will significantly degrade.	<ul style="list-style-type: none"> Blockages in pipes or clogged filters. A faulty pump that does not provide sufficient flow. Low refrigerant levels, restricting flow. Air bubbles in the cooling system, causing pressure fluctuations and inadequate heat transfer, especially if the system has not been properly purged. 	<ul style="list-style-type: none"> Cooling or heating efficiency decreases, leading to improper temperature maintenance in spaces. The system may overheat due to insufficient refrigerant flow, causing inadequate heat dissipation. An error code will appear on the control panel, alerting the operator that the issue needs to be resolved. The compressor and other critical components may become overloaded, reducing the lifespan of the equipment. 	<p>Check the filters and pipes for blockages and inspect the pump's functionality.</p> <p>If everything is operational, check the refrigerant level and refill or purge the system as necessary.</p> <p>Restart the system to verify adequate flow and clear the error code.</p> <p>Bleed the system to remove any air bubbles that may be obstructing proper flow.</p> <p>After restarting, ensure the flow is sufficient and that the error code clears.</p>

Code	Meaning	Description	Possible Consequences	Solution
E1:11	High Voltage Alarm	The system has detected overvoltage, which could potentially damage electronic components. High voltage is dangerous for the control panel, compressor, and other sensitive components, potentially causing serious malfunctions or complete failure. The source of the overvoltage may be power fluctuations, a faulty transformer, or other electrical problems.	<ul style="list-style-type: none"> Sensitive electronics, such as the control panel and compressor, may be damaged, leading to total system failure. The cooling or heating system may shut down as the overvoltage disrupts critical components. Repeated overvoltage occurrences can shorten component lifespan and increase maintenance needs. An error code will appear, warning the operator that immediate action is required to protect the system. 	<p>Check the system's power supply to identify the source of the overvoltage. It may be caused by external network problems, in which case a stabilizer or surge protection device should be installed to prevent future issues.</p> <p>Replace any damaged electrical components, such as transformers or control panels, if damage has been detected.</p> <p>Restart the system after resolving the overvoltage issue and verify that the problem has been resolved.</p> <p>Check the condition of components, and the error code will clear if no further issues are detected.</p>

Code	Meaning	Description	Possible Consequences	Solution
E1:13	Protection Against High Freshwater Outlet Temperature	The system provides protection against excessively high freshwater outlet temperatures. If the freshwater outlet temperature exceeds the allowed limit, the system intervenes automatically to protect the equipment. High temperatures can damage the heat exchanger and other key components and reduce system efficiency.	<ul style="list-style-type: none"> Excessively high freshwater outlet temperatures jeopardize the cooling system's efficiency and can damage connected components. Overheating in the heat exchanger may create undesirable temperature differences, leading to system malfunction. The system may display an error code and shut down to prevent more severe damage. 	<p>First, check the cooling system for proper freshwater flow and ensure the heat exchanger is functioning correctly. Blockages or faulty components may hinder adequate cooling.</p> <p>Inspect or replace the freshwater outlet temperature sensor if it is malfunctioning, as it could affect temperature monitoring and regulation.</p> <p>Ensure the coolant level and flow are appropriate, and check the heat exchanger and related components for any issues.</p> <p>Restart the system after necessary repairs to verify that the temperature protection mechanism is functioning correctly.</p>
E1:14	Protection Against Low Freshwater Outlet Temperature	This feature protects the system from excessively low freshwater outlet temperatures. Extremely low temperatures can cause problems such as system freezing or reduced heat exchanger efficiency. If the outlet temperature drops below the permitted threshold, the system intervenes automatically to prevent equipment damage and operational disturbances.	<ul style="list-style-type: none"> The water in the cooling system could freeze, causing damage to pipes, pumps, or heat exchangers. System efficiency may drop as low temperatures can interfere with the cooling cycle and proper heat dissipation. An error code will appear on the control panel, warning the operator of the issue, which may require urgent attention. 	<p>Check the freshwater outlet temperature sensor for proper function and replace it if necessary.</p> <p>Investigate the coolant and freshwater circulation to ensure the appropriate temperature range is maintained.</p> <p>Ensure that the system regulates the cooling process adequately and prevents the freshwater temperature from falling below the critical threshold.</p> <p>After performing repairs, restart the system and verify that the temperature protection mechanism is working properly.</p>

Code	Meaning	Description	Possible Causes	Possible Consequences	Solution
E1:15	Protection of Freshwater Inlet and Outlet Temperature Difference	The system monitors the temperature difference between the freshwater inlet and outlet, activating protective mechanisms if the difference becomes too large or too small. Ideally, the temperature difference should be between 5°C and 10°C, ensuring efficient operation of the cooling system. If the difference falls outside this range, it signals reduced efficiency, possibly due to faulty heat exchange or water flow issues.	<ul style="list-style-type: none"> Insufficient water flow due to clogged filters or a faulty pump, reducing system performance. Heat exchanger malfunction, impeding proper heat transfer between the freshwater and coolant. Leaks or air bubbles in the system, reducing water flow and the overall efficiency. 	<ul style="list-style-type: none"> The cooling system may not maintain an optimal cooling cycle, leading to reduced cooling capacity and increased energy consumption. Components like the heat exchanger may be overworked, causing long-term damage. The system may shut down to prevent further damage, displaying an error code. 	<p>Clean water filters and inspect the pump to ensure adequate water flow in the system.</p> <p>Check the heat exchanger for proper operation and confirm that there are no blockages or damage.</p> <p>Bleed the system to remove any air bubbles that could obstruct proper water flow.</p> <p>Check for any leaks and fix them as necessary.</p>
E1:17	Protection Against High Compressor Forward Temperature	The system has detected that the forward temperature on the compressor discharge side has reached a critical level, activating protective measures to safeguard the compressor and other components.	<ul style="list-style-type: none"> Insufficient refrigerant flow, which fails to provide adequate cooling and leads to compressor overheating. Refrigerant leaks, reducing the system's cooling capacity and causing temperature rise. Insufficient water flow in the condenser, preventing efficient heat dissipation from the heat exchanger and drastically reducing the cooling process's efficiency. Internal compressor failure, causing abnormal pressure and temperature increases. 	<ul style="list-style-type: none"> Compressor overheating can lead to long-term damage or complete failure. The system may shut down to prevent further damage and display an error code. Reduced compressor performance or failure will significantly impact the overall cooling system's capacity. 	<p>Inspect the refrigerant flow to ensure it is at the correct speed and volume.</p> <p>Check water flow and pump performance to confirm sufficient flow to the condenser. If the pump is not providing adequate water flow, the heat cannot effectively leave the system.</p> <p>Check for clogged water filters, as they may hinder water flow and cause heat buildup.</p> <p>Inspect the refrigerant level for any leaks that could be reducing cooling capacity.</p> <p>Ensure the compressor is functioning correctly and has no internal failures or overloads causing the temperature rise.</p> <p>Restart the system after performing necessary repairs and monitor temperature readings to restore normal operation.</p>

Code	Meaning	Description	Possible Causes	Possible Consequences	Solution
E1:18	Compressor Controller Communication Failure	Communication between the compressor inverter unit and the central system has been interrupted or is faulty. This controller unit is responsible for overseeing the compressor's operation, including temperature, pressure, and flow data monitoring. A communication failure prevents proper control of the compressor, potentially leading to malfunction or complete system shutdown.	<ul style="list-style-type: none"> • Faulty wiring or connection issues between the compressor and the controller unit. • Software error in the controller unit or communication module of the central system. • Power supply problem at the compressor controller unit, hindering proper communication. • Electrical interference disrupting the communication signals. 	<ul style="list-style-type: none"> • The compressor may not receive proper control signals, leading to malfunction or shutdown. • The cooling system's efficiency may decrease due to improper compressor regulation. • Safety mechanisms may be activated, and warning alerts may appear on the control panel to protect the compressor from further damage. 	<p>Check wiring and connections: Ensure all connections are properly functioning, and no cables are damaged or loose.</p> <p>Inspect the controller unit's power supply: Verify the controller unit is operating correctly and receiving adequate power.</p> <p>Update or inspect the software: If a software issue is suspected, update the system's software or restart the communication modules.</p> <p>Check for electrical interference: Ensure no disruptive signals are interfering with the communication between the controller unit and the central system.</p>

Code	Meaning	Description	Possible Causes	Possible Consequences	Solution
E1:33	IPM Overcurrent Protection	<p>The Intelligent Power Module (IPM) has detected an overcurrent or overvoltage and has activated protection mechanisms. The IPM regulates motor current and switching processes and includes components such as transistors, diodes, and various protection features to ensure safe system operation.</p> <p>The IPM controls the current and speed of the compressor. It contains components such as transistors and diodes that generate heat during operation. The IPM relies on the seawater condenser for cooling, making proper seawater circulation within the system critically important.</p>	<ul style="list-style-type: none"> Overcurrent to the compressor: If the compressor draws too much current, the IPM detects this abnormality and activates protection to prevent damage. Short circuit in the system: A short circuit in a component may cause an overvoltage, which the IPM detects and blocks to prevent severe damage. Cooling issues within the IPM: If the IPM overheats due to inadequate cooling, it can malfunction. Faulty transistors or diodes: Component failure within the IPM may result in overcurrent or overvoltage. During this winter period, seawater temperatures are lower. If the seawater temperature is too cold, the compressor may freeze the water in the condenser during operation, causing the seawater flow to stop. 	<ul style="list-style-type: none"> The compressor's power supply may be interrupted, causing system performance to decline or shut down. IPM protection activation may stop the system to prevent severe damage to the compressor, controller, or other related components. The system may display an error code indicating overcurrent or overvoltage. 	<p>Check system power supply: Ensure there are no overvoltage or overcurrent conditions and that the current flow meets prescribed limits.</p> <p>Set parameter 15 to adjust the frequency to 55Hz. After that the compressor will working lower frequency.</p> <p>Inspect the compressor: Ensure the compressor is not drawing excessive current and check for any short circuits or other faulty components.</p> <p>Examine the IPM cooling system: Ensure the cooling system is functioning properly and that the IPM is not overheating.</p> <p>Replace faulty IPM components: If transistors, diodes, or other internal parts have failed, replace them to restore system function.</p> <p>Restart the system: After repairs, restart the system and ensure the issue does not reoccur.</p>
E1:34	Compressor Drive Failure	<p>The compressor drive system, which includes the motor and associated control systems, has failed or detected an operational issue. This failure typically stems from mechanical motor problems, control unit faults, overloads, or electrical errors that prevent proper compressor function.</p>	<ul style="list-style-type: none"> Motor failure: Mechanical issues with the compressor motor, such as bearing wear or rotor failure, can cause the drive to shut down. Overload: The motor is under excessive load, leading to increased current draw and motor shutdown. Electrical fault: Faulty electrical connections, wiring issues, or power supply disturbances may cause the drive to fail. Control unit failure: A malfunction in the compressor control unit, such as a motor control module failure, can prevent proper motor operation. Short circuit or leakage: A short circuit or leakage in the system's electrical network may cause compressor drive failure. 	<ul style="list-style-type: none"> The compressor may shut down, interrupting the cooling or heating process. System efficiency will drop significantly or completely cease until the issue is resolved. The system may suffer further damage if the problem is not addressed promptly, potentially leading to component failures. 	<p>Inspect the motor: Check the motor's mechanical condition, focusing on bearings, the rotor, and other moving parts that may fail.</p> <p>Examine electrical connections: Ensure there are no broken or loose wires, short circuits, or other electrical issues preventing the motor from operating.</p> <p>Check the control unit: Ensure the compressor control unit is functioning properly and that no modules or control functions are faulty.</p> <p>Monitor motor temperature and current draw: In case of overheating or excessive current draw, inspect the motor's cooling system and load conditions.</p> <p>Replace faulty components: If any mechanical or electrical parts are defective, replace them to restore the compressor's operation.</p> <p>Restart the system: After repairs, restart the system and ensure the issue does not persist.</p>

Code	Meaning	Description	Possible Causes	Possible Consequences	Solution
E1:35	Compressor Phase Electric Current Fault	An issue with the electrical current in one of the compressor's phases has been detected. This fault is typically the result of phase shift, imbalance between phases, or overcurrent. In three-phase power systems, the balance of current between the phases is crucial for proper compressor operation. If an imbalance occurs or overcurrent happens in one phase, it can reduce compressor performance and potentially cause severe damage.	<ul style="list-style-type: none"> • Phase shift or imbalance: Unequal current between the compressor's three phases due to voltage differences or faulty phase connections. • Overcurrent in one phase: Excessive current in one phase leads to phase imbalance. • Faulty wiring or connection issues: Damaged or loose connections in one of the phase wires can cause current irregularities. • Mechanical issues in the compressor: Problems like worn-out bearings or rotor faults can increase or imbalance current consumption. • Faulty power supply: Voltage fluctuations or a malfunctioning transformer in the power network can cause phase imbalances. 	<ul style="list-style-type: none"> • Phase imbalance can cause motor overheating or damage, leading to long-term failure. • Cooling system performance can drop significantly, potentially slowing or stopping system operation. • Prolonged imbalance may cause premature compressor failure and expensive repairs. 	<p>Check phase currents: Measure the current in all three phases to ensure balance. If there's a discrepancy, locate the cause of the imbalance.</p> <p>Inspect wiring and connections: Verify that all phase wires are intact and connections are secure.</p> <p>Examine power supply: Ensure the system is receiving properly phased and balanced voltage from the electrical network.</p> <p>Check the compressor for mechanical issues: Inspect internal mechanical components like bearings for wear or other issues that might disrupt phase balance.</p> <p>Restart the system: After completing necessary repairs, restart the system and check if the phase balance has returned to normal.</p>
E1:36	Input Voltage Phase Loss	One phase in the three-phase power supply to the compressor or other equipment has been lost or experienced a significant voltage drop. This phase loss, also known as phase failure, can cause severe operational issues for equipment dependent on balanced three-phase power. Proper operation requires that all three phases provide consistent current and voltage. If one phase is lost or experiences a significant voltage drop, it may lead to compressor failure or motor overload.	<ul style="list-style-type: none"> • Phase wire failure or disconnection: One or more phase wires may be damaged or disconnected, causing phase loss. • Faulty switches or breakers: Defective switches, breakers, or fuses may prevent one phase from receiving sufficient power. • Power outage in the electrical network: Phase loss or voltage fluctuations in the utility network. • Loose or damaged electrical connections: Improperly secured wires or connectors may cause voltage drops or phase loss. 	<ul style="list-style-type: none"> • Compressor overload: The remaining phases may take on more load, leading to compressor overheating and potential failure. • System shutdown: The three-phase system cannot operate effectively on two-phase power, leading to a shutdown. • Equipment damage: Extended phase loss may result in severe compressor damage, especially if the motor continues trying to run on two phases. 	<p>Inspect phase wires and connections: Ensure that all phase wires are intact and securely connected.</p> <p>Check switches and breakers: Verify that no faulty breakers or switches are causing phase loss.</p> <p>Examine power supply: If the issue lies with the power supply, contact the utility provider to determine if there is a network outage or voltage fluctuation.</p> <p>Install phase loss protection devices: Consider installing a device that detects phase loss and shuts down the system before significant damage occurs.</p> <p>Restart the system: After resolving the issue, restart the system and confirm that the voltage across all phases is within acceptable limits.</p>

Code	Meaning	Description	Possible Causes	Possible Consequences	Solution
E1:37	Phase Current Sampling Fault	This error occurs when the system cannot correctly measure or monitor the three-phase current required for compressor operation. Incorrect current sampling may result in the compressor not receiving proper control signals, leading to malfunction, decreased performance, or system shutdown.	<ul style="list-style-type: none"> • Faulty current sensors: Sensors (such as current transformers) measuring the three-phase current may fail, leading to inaccurate or incorrect sampling. • Wiring issues: Damaged or loose connections in the current measurement circuit may disrupt accurate phase current readings. • Control unit failure: The compressor control unit may not process the phase current sampling properly, causing incorrect signals to the motor. • Interference or noise: Electrical disturbances or interference may disrupt the current sampling process, leading to faulty readings. 	<ul style="list-style-type: none"> • Compressor malfunction: Incorrect current measurement affects control, leading to malfunction. • System overheating: The compressor may not receive accurate current data, leading to overload or reduced efficiency. • System shutdown: The system may shut down to prevent further damage to the compressor or other components. 	<p>Check current sensors: Ensure the sensors measuring three-phase current are functioning properly and not defective.</p> <p>Inspect wiring: Verify that all connections from the sensors to the control unit are intact and properly connected.</p> <p>Examine the control unit: Ensure the control unit processes phase current sampling data accurately.</p> <p>Filter electrical interference: Confirm that there is no electrical noise or interference affecting the phase current measurement.</p> <p>Restart the system: After repairing or replacing faulty components, restart the system to ensure the error does not reoccur.</p>
E1:38	Abnormal Communication with Upper Computer	This error occurs when communication between the upper printed circuit board (PCB) of the compressor control system and the compressor control unit is disrupted. Proper data exchange between the various control modules is essential for compressor operation. Communication failure may lead to faulty compressor control or complete system shutdown.	<ul style="list-style-type: none"> • Faulty wiring or connection issues: Communication cables between control units may be damaged or loose, causing the error. • Upper PCB failure: The compressor's upper PCB may malfunction, failing to send or receive proper signals. • Software error: A software issue in the control system may prevent proper communication. • Electrical interference: Disruptive electrical noise or interference may obstruct communication between control units. 	<ul style="list-style-type: none"> • Compressor fails to receive commands: This can lead to malfunction or shutdown. • Cooling or heating process interruption: The system may stop regulating the compressor and related components. • Reduced system performance or shutdown: The system will not operate efficiently until the communication issue is resolved. 	<p>Check communication cables and connections: Ensure that all communication cables between the control system and the PCB are securely connected and undamaged.</p> <p>Inspect the upper PCB: Ensure the PCB is working correctly with no damaged components.</p> <p>Update or restart software: If a software issue is suspected, update or restart the control system's software.</p> <p>Filter electrical interference: Ensure no electrical interference or noise is disrupting communication signals.</p> <p>Restart the system: After completing repairs, restart the system to verify communication between the control system and the PCB has been restored.</p>

Code	Meaning	Description	Possible Causes	Possible Consequences	Solution
E1:39	EE Fault (EEPROM Memory Fault)	This error occurs when the system is unable to communicate with or access data stored in the EEPROM (Electrically Erasable Programmable Read-Only Memory). The EEPROM stores critical settings and configuration data necessary for the compressor and control system's proper operation. If the system cannot access this data, it will negatively affect compressor performance and overall system operation.	<ul style="list-style-type: none"> • EEPROM failure: The data stored in the EEPROM may be corrupted, or the memory module may malfunction, causing communication issues. • Faulty read/write process: The system may be unable to read from or write to the EEPROM due to communication or control problems. • Voltage fluctuations: Power supply issues, such as voltage fluctuations, can damage EEPROM data or prevent normal operation. • Software error: A software malfunction in the control system may block access to the EEPROM. 	<ul style="list-style-type: none"> • The compressor or control system may operate incorrectly because it cannot retrieve necessary configuration settings. • The system may fail to start properly or enter a fault mode. • Overall system efficiency may decrease, or control functions may halt until the issue is resolved. 	<p>Check the EEPROM: Ensure the EEPROM is functioning properly and that there is no data corruption or hardware failure.</p> <p>Restore or update configuration data: If possible, restore or rewrite the configuration data stored in the EEPROM.</p> <p>Check power supply: Ensure there are no voltage fluctuations or power issues affecting the EEPROM's performance.</p> <p>Update or reinstall software: If a software error is suspected, update or reinstall the control system software to restore communication with the EEPROM.</p> <p>Replace the EEPROM module: If the EEPROM is faulty, replacing the module may be necessary to restore proper operation.</p> <p>Restart the system: After restoring data or completing repairs, restart the system to verify the error has been resolved.</p>
E1:40	DC Bus Overvoltage/Undervoltage	This error occurs when the DC bus voltage in the compressor is too high (overvoltage) or too low (undervoltage). The DC bus plays a key role in power distribution, converting AC (alternating current) to DC (direct current) for motor controllers and other devices. Maintaining the correct voltage range is crucial for the system's safe and efficient operation.	<ul style="list-style-type: none"> • Power supply voltage fluctuations: Voltage variations in the electrical network can cause overvoltage or undervoltage in the DC bus. • Faulty capacitors or components in the inverter: Defective capacitors or other energy management components can destabilize power supply. • Voltage regulation failure: The inverter or voltage regulation system may fail to manage fluctuations properly, causing excessive or insufficient voltage in the DC bus. • Overload or short circuit: Sudden load increases or short circuits in the system can cause voltage spikes or drops. 	<ul style="list-style-type: none"> • Overcurrent or overheating: Excessively high voltage can overload circuits, leading to overheating and severe system damage. • System shutdown or underperformance: Low voltage can cause the system to shut down, or the compressor may not function properly, leading to reduced performance. • Equipment damage: Prolonged overvoltage or undervoltage in the DC bus can damage motor controllers, inverters, and other key components. 	<p>Check the power supply: Ensure that the power supply is stable and there are no significant voltage fluctuations. Use a voltage stabilizer or UPS if necessary.</p> <p>Inspect inverter components: Check capacitors, voltage regulation circuits, and other critical components in the inverter to ensure they function properly.</p> <p>Measure DC bus voltage: Measure the DC bus voltage to verify that it is within the required range. If not, the inverter's regulation system may be at fault.</p> <p>Check for overloads or short circuits: Verify that there are no excessive loads or short circuits in the system causing voltage fluctuations.</p> <p>Replace faulty components: If any components, such as capacitors or voltage regulators, are faulty, replace them to restore system stability.</p> <p>Restart the system: After repairs, restart the system and verify that the voltage is back within the proper range.</p>

Code	Meaning	Description	Possible Causes	Possible Consequences	Solution
E1:41	AC Input Overvoltage/ Undervoltage	This error occurs when the AC input voltage exceeds the safe operating range, either due to overvoltage or undervoltage. The system requires the AC input voltage to remain within a specified range for optimal operation. Excessively high or low voltage can cause system components to malfunction, leading to poor performance or damage.	<ul style="list-style-type: none"> • Power grid voltage fluctuations: Voltage spikes or drops, network overloads, or power outages can cause the AC input voltage to deviate. • Faulty electrical infrastructure: Defective transformers, breakers, or other components in the power supply can cause overvoltage or undervoltage. • Improper wiring: Damaged or improperly secured wires or connectors can lead to voltage issues. • Overloaded circuits: System overloads can cause voltage drops or excessive power input. 	<ul style="list-style-type: none"> • System malfunctions: High voltage can overload components, leading to overheating and failure. • System shutdown: Low voltage can prevent the system from receiving adequate power, resulting in decreased performance or shutdown. • Component damage: Voltage fluctuations, particularly overvoltage, can damage circuits and system components, resulting in costly repairs. 	<p>Check the power supply: Ensure that the power supply is stable, with no significant voltage spikes or drops. Contact the utility provider if needed.</p> <p>Inspect wiring and connections: Verify that the wires and connectors are in good condition and properly sized for the system's requirements.</p> <p>Check for system overloads: Verify that the system is not overloaded, and if necessary, distribute the load across multiple circuits to reduce the risk of overcurrent.</p> <p>Restart the system: After making necessary adjustments or repairs, restart the system and confirm that the input voltage is within the proper range.</p>
E1:42	AC Input Overcurrent	This fault occurs when the system's AC input current exceeds the safe operational limit. Excessive current can cause overheating, damage, or operational disturbances to critical system components, especially the compressor and electrical parts. Overcurrent can severely reduce the system's reliability and pose significant risks.	<ul style="list-style-type: none"> • System overload: Excessive load on the system, such as high energy demand from the compressor, can cause overcurrent. • Short circuit: A short circuit in any component may lead to overcurrent, causing severe damage to the system. • Faulty power supply: An unstable or defective power supply can result in overcurrent. • Defective electrical components: The compressor or other electrical components may fail, leading to an overcurrent situation. • Faulty fuse or breaker: If the fuse or breaker is defective, it may fail to regulate current properly. 	<ul style="list-style-type: none"> • Compressor failure: Excessive current may damage the compressor, leading to shorter lifespan or complete failure. • System shutdown: The system may automatically shut down to prevent further damage from overcurrent. • Overheating of components: Overcurrent can cause electrical components to overheat, potentially posing a fire risk. • Activation of safety systems: Fuses or breakers may trip to cut off power and protect the system from further damage. 	<p>Check the load: Ensure the system is not overloaded, and confirm that the compressor and other components are operating within the normal current range.</p> <p>Inspect electrical circuits: Check for short circuits or faulty electrical circuits causing overcurrent.</p> <p>Check the power supply: Ensure that the system is connected to a stable power source without overcurrent or voltage spikes.</p> <p>Inspect the compressor: Verify that the compressor is functioning properly without defects.</p> <p>Check fuses and breakers: Ensure that fuses and breakers are operational and correctly rated for the system's power needs.</p> <p>Restart the system: After making the necessary repairs, restart the system and verify that the input current is within the safe operational limit.</p>

Code	Meaning	Description	Possible Causes	Possible Consequences	Solution
E1:43	Input Voltage Sampling Fault	This error occurs when there is an issue with sampling or measuring the system's input voltage. Inaccurate or faulty voltage detection can lead to improper control signals being sent to the system, resulting in poor performance, overloads, or incorrect operation, compromising the stability and safety of the system.	<ul style="list-style-type: none"> • Faulty voltage sensor: The sensor responsible for measuring the input voltage may malfunction, leading to inaccurate readings. • Wiring issues: Damaged or loose connections in the voltage sampling cables may cause incorrect readings. • Control unit fault: The circuits responsible for voltage measurement within the control unit may be malfunctioning, providing incorrect data. • Electrical interference: Interference from external electrical signals can affect the accuracy of voltage readings. • Unstable power supply: Fluctuations in the power supply can lead to incorrect sampling results. 	<ul style="list-style-type: none"> • Faulty control signals: Incorrect voltage readings may cause the control system to send improper signals, leading to malfunctions. • Overload: If the system doesn't receive accurate voltage data, it may experience overloads or underperformance, damaging components over time. • System shutdown: The control system may shut down the unit to prevent further damage to the compressor and critical components. 	<p>Check voltage sensors: Ensure that the voltage sensors are working correctly and providing accurate readings.</p> <p>Inspect wiring and connections: Verify that the voltage sampling cables are intact and securely connected.</p> <p>Examine control unit circuits: Inspect the control unit circuits to ensure they are functioning properly and delivering accurate voltage measurements.</p> <p>Filter electrical interference: Ensure that there is no external interference affecting the voltage sampling process.</p> <p>Stabilize the power supply: Ensure the power supply is stable, with no significant fluctuations.</p> <p>Restart the system: After addressing the issues, restart the system to confirm the voltage sampling accuracy is restored.</p>
E1:44	Freshwater Condenser Temperature Sensor Malfunction	This fault occurs when the temperature sensor in the freshwater condenser malfunctions, which measures the temperature of the condenser's water. The sensor is critical for monitoring the condenser's temperature to ensure that the cooling process is efficient. A faulty sensor may lead to inaccurate temperature readings, causing overheating or insufficient cooling.	<ul style="list-style-type: none"> • Sensor failure: The sensor may fail, providing inaccurate temperature readings. • Wiring issues: Damaged or loose connections between the sensor and the control system can affect sensor performance. • Sensor displacement: The sensor may be misaligned or have moved from its correct position. • Dirt or buildup: Dirt or scale on the condenser may interfere with accurate temperature readings. 	<ul style="list-style-type: none"> • Inadequate cooling: If the sensor provides incorrect data, the system may not be able to regulate the cooling process properly, leading to overheating or insufficient cooling. • Compressor overload: The compressor may be overloaded if the system cannot accurately monitor condenser temperatures, potentially leading to long-term damage. • System shutdown: The control system may shut down to prevent damage to the condenser or compressor. 	<p>Check the temperature sensor: Ensure the sensor is functioning properly and providing accurate readings.</p> <p>Inspect wiring and connections: Verify that the connections between the sensor and the control system are intact.</p> <p>Clean the condenser: Remove dirt or buildup from the condenser to ensure accurate sensor readings.</p> <p>Reposition the sensor: Ensure the sensor is correctly placed and properly secured.</p> <p>Replace the faulty sensor: If the sensor is defective, replace it to restore accurate temperature monitoring.</p> <p>Restart the system: After repairs, restart the system to ensure the sensor operates normally.</p>

Code	Meaning	Description	Possible Causes	Possible Consequences	Solution
E1:45	Overvoltage (Ov) Sensor Malfunction	This fault occurs when the overvoltage (Ov) sensor malfunctions. The Ov sensor monitors for excessive voltage on the electrical network to protect the system components. If the sensor fails, the system becomes vulnerable to voltage spikes, which can damage the compressor, electrical components, and the control system.	<ul style="list-style-type: none"> • Faulty Ov sensor: The sensor itself may fail and become unable to detect overvoltage properly. • Wiring issues: Loose or damaged connections between the sensor and the control system may lead to malfunction. • Sensor misalignment or misconfiguration: The sensor may be improperly calibrated or displaced from its proper position. • Frequent voltage fluctuations: If there are frequent power fluctuations, the Ov sensor may become overloaded and fail. 	<ul style="list-style-type: none"> • Lack of overvoltage protection: Without proper protection, the system is exposed to voltage surges, risking damage to electrical components. • Compressor failure: Overvoltage can damage the compressor, potentially leading to short-term breakdown. • System shutdown: The system may shut down to prevent damage, but the lack of overvoltage protection means it remains vulnerable until the sensor is fixed. 	<p>Check the Ov sensor: Ensure the sensor is functioning correctly and detecting voltage surges.</p> <p>Inspect wiring and connections: Confirm the wiring between the sensor and the control system is intact and properly connected.</p> <p>Recalibrate the sensor: If misaligned, recalibrate the sensor to ensure accurate voltage monitoring.</p> <p>Examine the power network: Check for frequent voltage spikes or overvoltage conditions on the electrical network.</p> <p>Replace the faulty sensor: If the Ov sensor is defective, replace it to restore proper protection.</p> <p>Restart the system: After repairs, restart the system to verify that the Ov sensor is working properly.</p>
E1:46	OHB (Overheat Block) Sensor Malfunction	This fault occurs when the sensor responsible for overheat protection (OHB sensor) malfunctions. The OHB sensor is critical for ensuring the system's safety, as it detects overheating risks and activates protective mechanisms to prevent overheating. If the OHB sensor fails, the system's overheating protection may not function correctly, leading to potential damage.	<ul style="list-style-type: none"> • Faulty OHB sensor: The sensor may malfunction, providing incorrect data about the system's overheating status. • Wiring issues: Damaged or loose connections between the OHB sensor and the control system may disrupt data transmission. • Incorrect installation: The sensor may be incorrectly installed or dislodged from its position, preventing it from accurately measuring temperature. • Voltage fluctuations or electrical issues: Electrical disturbances, voltage fluctuations, or short circuits may interfere with the OHB sensor's performance. 	<ul style="list-style-type: none"> • Overheating risk: If the OHB sensor malfunctions, the system may not detect overheating, leading to excessive heat buildup and component damage. • Compressor failure: Overheating can cause the compressor to fail, resulting in a shorter lifespan or complete failure. • System shutdown: The control system may shut down the system to prevent overheating, but the shutdown may be delayed or missed if the sensor is faulty. 	<p>Check the OHB sensor: Ensure the sensor is functioning properly and providing accurate temperature readings.</p> <p>Inspect wiring and connections: Verify that the connections between the sensor and the control system are secure and undamaged.</p> <p>Reposition the sensor: Ensure the sensor is correctly installed and positioned to detect overheating effectively.</p> <p>Check for electrical issues: Inspect for electrical disturbances or voltage fluctuations that could interfere with sensor performance.</p> <p>Replace the faulty sensor: If the OHB sensor is defective, replace it with a new, working sensor to restore proper overheating protection.</p> <p>Restart the system: After making the necessary repairs, restart the system and check that the OHB sensor is functioning correctly.</p>

Code	Meaning	Description	Possible Causes	Possible Consequences	Solution
E1:48	Input Current Sampling Fault	This error occurs when there is an issue with measuring or sampling the system's input current. Inaccurate input current detection provides incorrect data to the control system, preventing accurate regulation and leading to potential performance issues.	<ul style="list-style-type: none"> • Faulty current sensor: The sensor responsible for current sampling may malfunction, providing inaccurate data to the control system. • Wiring issues: Damaged or loose connections between the current sensor and the control system. • Control system malfunction: The control unit may not properly process input current data for regulation. • Electrical interference: External electrical signals or interference may disrupt the current sampling process, leading to incorrect data. • Unstable power supply: Voltage fluctuations or power supply issues can affect the accuracy of current sampling. 	<ul style="list-style-type: none"> • Faulty control signals: Incorrect current sampling may cause the control system to send improper signals to the compressor, leading to faulty operation. • Overload or underload: The system may experience overvoltage or underload due to inaccurate current data, potentially damaging components. • System shutdown: The system may shut down to prevent damage caused by faulty current sampling. 	<p>Check the current sensor: Ensure the sensor responsible for measuring input current is functioning correctly and providing accurate data.</p> <p>Inspect wiring and connections: Verify that connections between the current sensor and the control system are intact and securely fastened.</p> <p>Check the control system: Ensure that the control unit can process input current data accurately.</p> <p>Filter electrical interference: Check for any external electrical interference that may be affecting current measurement accuracy.</p> <p>Ensure stable power supply: Verify that the system is connected to a stable power source without significant voltage fluctuations or power loss.</p> <p>Restart the system: After repairs, restart the system to verify that proper current sampling has been restored.</p>
E1:49	Compressor Overcurrent Alarm	This fault occurs when the compressor's current draw exceeds the normal operating range, leading to an overcurrent condition. Excessive current draw indicates that the system is under heavy load, which could cause the compressor and other related electrical components to become overloaded and potentially damaged.	<ul style="list-style-type: none"> • Overload: The compressor is working under excessive load, such as high pressure or temperature, resulting in increased current draw. • Short circuit: A short circuit within the electrical system or the compressor can cause overcurrent. • Faulty capacitor or start circuit: A defective capacitor or starter circuit can increase current draw. • Cooling issues: Blockages in the cooling system (e.g., clogged filters or improper refrigerant flow) force the compressor to work harder, leading to overcurrent. • Motor failure: Internal motor issues can result in excessive current consumption. 	<ul style="list-style-type: none"> • Compressor failure: Excessive current draw will damage the compressor, reducing its lifespan or leading to complete failure. • Overheating: Overcurrent can cause overheating in the compressor and other electrical components, resulting in further damage. • System shutdown: The system may automatically shut down to prevent further damage from overcurrent. 	<p>Check the compressor load: Ensure the compressor is not operating under excessive load and is set to proper pressure and temperature levels.</p> <p>Inspect the cooling system: Check refrigerant flow and clean clogged filters to reduce the compressor load.</p> <p>Check the capacitor and start circuit: Ensure these components function correctly and are not causing excessive current draw.</p> <p>Inspect the compressor motor: Check for internal damage or wear that could cause excessive current consumption.</p> <p>Check the electrical system: Ensure no short circuits or wiring faults are causing overcurrent.</p> <p>Replace faulty components: Replace any defective parts to prevent further compressor overcurrent issues.</p> <p>Restart the system: After repairs, restart the system and monitor the compressor's current draw to ensure it is within normal limits.</p>

Code	Meaning	Description	Possible Causes	Possible Consequences	Solution
E1:50	Compressor Weak Magnetic Protection Alarm	This fault occurs when the compressor's magnetic field is too weak, potentially affecting the motor's operation. An insufficient magnetic field can reduce motor efficiency and performance. The protection alarm activates to prevent damage caused by a weak magnetic field, which can lead to motor overload or failure.	<ul style="list-style-type: none"> • Faulty windings or magnetic components: The compressor motor's windings or magnetic components may be damaged or weakened, reducing the magnetic field. • Electrical power issues: Inadequate or unstable power supply can weaken the motor's magnetic field, lowering performance. • Faulty control unit: The compressor control system may fail to send the correct signals to maintain a strong magnetic field. • Compressor motor overload: Operating the compressor under excessive load can weaken the magnetic field. • Overheating: Excessive heat can damage the motor windings, reducing the magnetic field strength. 	<ul style="list-style-type: none"> • Reduced efficiency: A weak magnetic field prevents the motor from operating at full capacity, reducing system efficiency. • Compressor overload: The motor may consume more energy and wear out faster under a weak magnetic field. • System shutdown: The system may shut down to prevent motor damage from a weak magnetic field. 	<p>Inspect motor windings and magnetic components: Check for damage or wear in the windings and magnetic components.</p> <p>Ensure stable power supply: Verify that the system is receiving stable power without interruptions or fluctuations.</p> <p>Check the control unit: Ensure the control system is providing the correct signals to maintain the magnetic field.</p> <p>Check for signs of overheating: Ensure the motor is not overheating, which could weaken the magnetic field.</p> <p>Replace faulty components: Replace any damaged parts to restore motor performance.</p> <p>Restart the system: After repairs, restart the system and verify that the magnetic field strength has returned to normal.</p>
E1:51	IPM Overheat Alarm	This fault occurs when the Intelligent Power Module (IPM) overheats. The IPM controls power distribution to the motor, and overheating can affect motor performance and lead to system shutdown. Overheating may result from cooling system failures, excessive load, or environmental factors.	<ul style="list-style-type: none"> • Inadequate cooling: A malfunctioning cooling system, such as blocked vents or a failed fan, can cause IPM overheating. • Excessive load: The compressor or motor may draw too much power, causing the IPM to overheat. • High ambient temperature: Elevated environmental temperatures may contribute to IPM overheating, especially if cooling is inadequate. • Poor heat dissipation: Faulty heat dissipation components, such as heatsinks or thermal paste, may lead to overheating. • Faulty IPM components: Defective electronic components within the IPM can cause overheating. 	<ul style="list-style-type: none"> • System shutdown: The system may shut down to prevent further damage due to IPM overheating. • Component damage: Prolonged overheating can damage the IPM and other electronic components, leading to costly repairs. • Reduced efficiency: An overheated IPM may fail to manage power efficiently, lowering system performance. 	<p>Check the IPM cooling system: Ensure fans are operational and vents are clear. Clean any blockages if necessary.</p> <p>Monitor ambient temperature: Ensure the system is operating in a properly ventilated environment with manageable temperatures.</p> <p>Inspect heat dissipation components: Check heatsinks and thermal paste for damage or wear.</p> <p>Check the compressor load: Ensure the compressor is not drawing excessive power, which could overheat the IPM.</p> <p>Replace faulty IPM components: Replace damaged internal components to prevent future overheating.</p> <p>Restart the system: After making repairs, restart the system and verify that the IPM temperature has stabilized.</p>

Code	Meaning	Description	Possible Causes	Possible Consequences	Solution
E1:52	AC Input Undervoltage Alarm	This error occurs when the alternating current (AC) input voltage drops below the expected level, preventing the compressor, motors, and other system components from receiving enough power to function correctly. If the voltage is too low, system components may not receive the necessary current, causing performance issues or even system shutdown.	<ul style="list-style-type: none"> • Network voltage fluctuation: Fluctuations in the input power grid can result in low voltage. • Power supply issue: The power grid may be unable to provide stable voltage due to load peaks or infrastructure issues. • Wiring problem: Faulty or damaged wiring between the system and the power source can lead to voltage drops. • Faulty electrical components: Malfunctioning fuses, breakers, or other electrical components may fail to supply the system with proper voltage. 	<ul style="list-style-type: none"> • Decreased performance: Compressors and motors will not receive enough power, reducing cooling or heating capacity and overall performance. • System shutdown: The system may automatically shut down to protect sensitive components like the compressor from damage due to low voltage. • Component damage: Prolonged low voltage can harm electrical components, particularly motors, compressors, and control units. 	<p>Check power supply: Assess the stability of the power grid and verify there are no voltage fluctuations. If needed, contact the power provider.</p> <p>Use a voltage stabilizer: If the network produces frequent voltage fluctuations, consider installing a voltage stabilizer or uninterruptible power supply (UPS) to protect the system.</p> <p>Inspect wiring: Ensure cables and connections are undamaged and able to deliver proper voltage.</p> <p>Inspect electrical components: Verify fuses, breakers, and other electrical components are functioning correctly without faults.</p> <p>Replace faulty components: Replace any malfunctioning parts to restore stable power delivery to the system.</p> <p>Restart the system: After repairs, restart the system to ensure the input voltage has returned to the normal range.</p>
E1:53	AC Input Overcurrent Alarm	This alarm indicates that the alternating current (AC) input current has exceeded the maximum allowable level. Excessive current can strain the compressor and other electrical components, leading to potential damage and compromising the system's stability and reliability.	<ul style="list-style-type: none"> • Overload in the system: Compressors or other system components may draw too much current, causing the input current to exceed the limit. • Short circuit: A short circuit in the electrical circuits can cause voltage surges and overcurrent. • Faulty power supply: Voltage fluctuations or improper power supply from the electrical network can result in excessive current draw. • Faulty electrical components: Defective parts, such as motors, capacitors, or fuses, can lead to overcurrent. • Improper wiring: Damaged or undersized wiring may contribute to overcurrent. 	<ul style="list-style-type: none"> • System shutdown: The system may automatically shut down to prevent further damage caused by overcurrent. • Component damage: Prolonged overcurrent can harm compressors, motors, and other electrical components, especially fuses and breakers. • Overheating: Overcurrent can cause electrical components to overheat, leading to operational issues or fire hazards. 	<p>Check system load: Ensure compressors and other components are not drawing too much current, preventing overcurrent situations.</p> <p>Inspect system circuits: Verify that no short circuits are present and that all circuits function properly.</p> <p>Check power supply: Ensure the electrical grid provides stable voltage without surges or current fluctuations.</p> <p>Inspect wiring: Verify that cables are not damaged and have the proper current capacity.</p> <p>Replace faulty components: Replace malfunctioning electrical components like motors, capacitors, or fuses to prevent further overcurrent issues.</p> <p>Restart the system: After completing repairs, restart the system to confirm that input current has returned to normal.</p>

Code	Meaning	Description	Possible Causes	Possible Consequences	Solution
E1:54	EEPROM Fault Alarm	This error indicates that the system cannot properly access the EEPROM (Electrically Erasable Programmable Read-Only Memory) or has detected a fault in the stored data. The EEPROM stores critical system settings, configurations, and operational parameters. If it fails or the data becomes corrupted, the system may not operate correctly.	<ul style="list-style-type: none"> • Damaged or faulty EEPROM: The EEPROM memory may have corrupted data, or the EEPROM module itself may be faulty. • Faulty read/write process: Errors in writing to or reading from the EEPROM can occur due to hardware or software issues. • Power supply issues: Voltage fluctuations or power failures can corrupt EEPROM data. • Software failure: Software bugs in the control system may prevent proper access to or storage of EEPROM data. 	<ul style="list-style-type: none"> • System errors: The system cannot access correct settings or operational parameters, leading to malfunctions or shutdown. • Improper control functions: Without access to EEPROM data, the control system cannot maintain optimal operation. • System shutdown: In severe cases, the control system may completely shut down until the EEPROM issue is resolved. 	<p>Check EEPROM memory: Ensure that the EEPROM module is functioning correctly and is free from physical or electronic damage.</p> <p>Restore or rewrite data: If possible, restore or rewrite the configuration data stored in the EEPROM.</p> <p>Update system software: If the issue is software-related, update or reinstall the control system software, ensuring proper data access.</p> <p>Check power supply: Verify that there are no voltage fluctuations or power outages affecting the EEPROM.</p> <p>Replace faulty EEPROM module: If the EEPROM is damaged, replace it with a new module to restore proper operation.</p> <p>Restart the system: Once data is restored or the module is replaced, restart the system to confirm that the issue is resolved.</p>
E1:57	IPM Overheating Shutdown	This error indicates that the Intelligent Power Module (IPM) has overheated, and the system has automatically shut down the compressor or affected equipment to prevent further damage. The IPM regulates power delivery to the motor, and overheating can lead to module failure or reduced compressor efficiency. The system shutdown serves as a protective measure to prevent serious failures.	<ul style="list-style-type: none"> • Inadequate cooling: Faulty cooling fans or blocked ventilation can cause the IPM to overheat. • Excessive current draw: Compressors or motors drawing too much current can overload and overheat the IPM. • High ambient temperature: High environmental temperatures can exacerbate IPM heating, especially if the cooling system is compromised. • Poor heat dissipation: Faulty heatsinks or thermal materials within the IPM can cause internal overheating. • Faulty IPM components: Damaged components, such as transistors or switching elements within the IPM, can cause overheating. 	<ul style="list-style-type: none"> • System shutdown: The system automatically shuts down to prevent further damage to the IPM and compressor. • Compressor performance reduction: Compressor efficiency may decline, leading to a drop in overall system performance. • Component damage: Prolonged overheating can damage the IPM and other sensitive electrical components, leading to costly repairs. 	<p>Inspect the cooling system: Ensure that cooling fans and ventilation are working correctly and are free from blockages. Clean as needed.</p> <p>Check ambient temperature: Verify that the system operates in a well-ventilated environment with manageable temperatures.</p> <p>Inspect heat dissipation: Check the heatsinks and thermal materials within the IPM to ensure they function correctly.</p> <p>Check current load: Ensure that the compressor is not drawing excessive current, which could cause the IPM to overheat.</p> <p>Replace faulty IPM components: If any internal components of the IPM are damaged, replace them to fix overheating problems.</p> <p>Restart the system: After repairs, restart the system and confirm that the IPM is no longer overheating.</p>

OPERATION CONTROL

Display Overview

The control panel of the MBC Marine Variable Chiller marine air conditioning systems is equipped with an intuitive display that provides real-time information about various operational parameters of the system. The data displayed allows users to easily monitor the system's status and performance, as well as quickly make any necessary adjustments. Key information on the display includes temperatures, pressure readings, compressor frequency, and electrical parameters. Navigating the control panel is straightforward, utilizing buttons for back, forward, and modification functions.

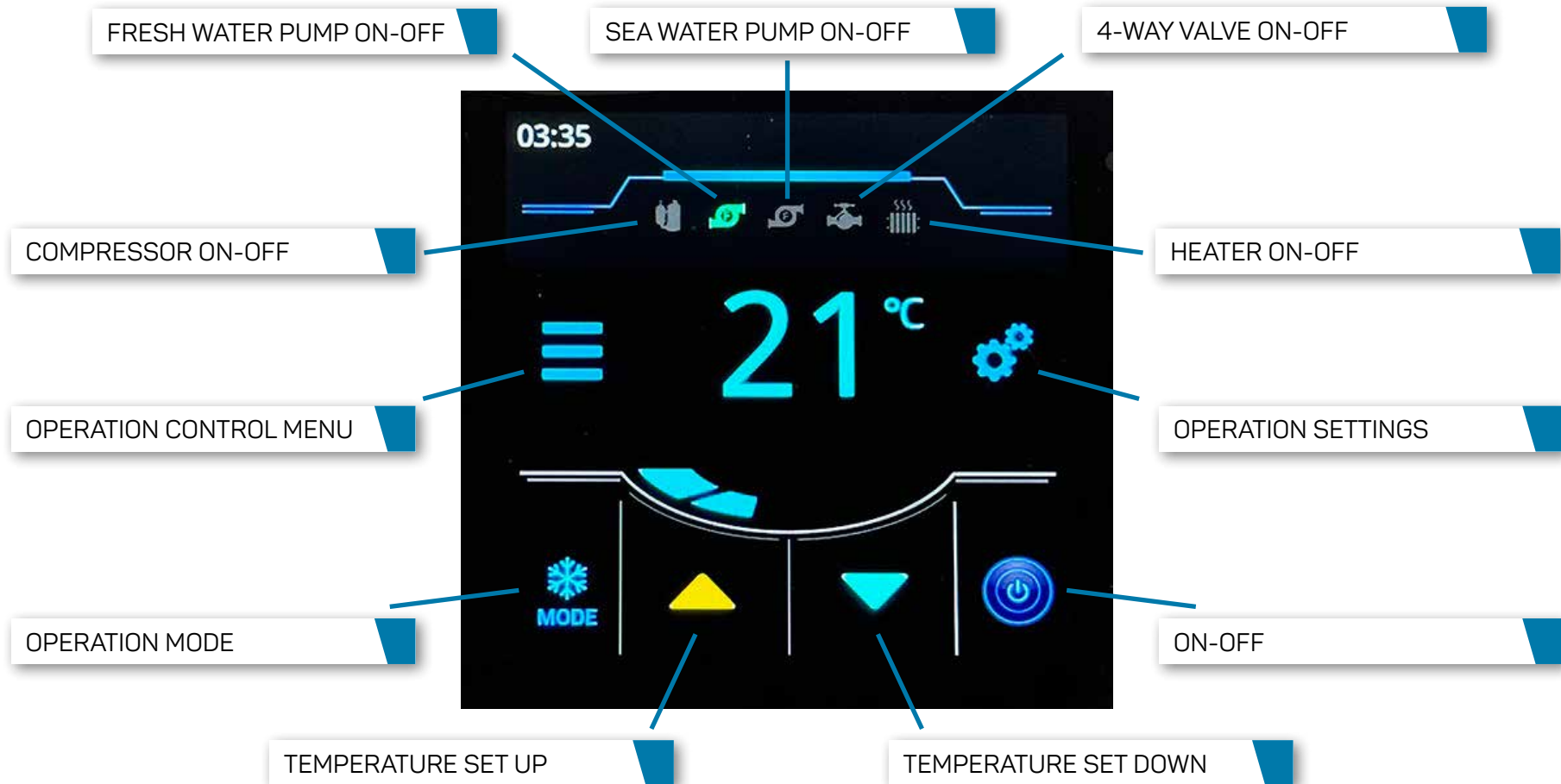



Parameter	Explanation
(Exhaust Temp.) - Compressor discharge	This parameter shows the temperature of the refrigerant exiting the compressor, directly after the refrigerant has passed through the compressor and has been pressurized.
(Suction Temp.) - Compressor suction temperature	This temperature indicates the temperature of the refrigerant entering the compressor. This value helps to understand the condition of the refrigerant before entering the compressor, i.e., whether it has cooled sufficiently in the evaporator before being compressed again.
(Suction saturation temp.) - Compressor suction saturation temperature	This value shows the temperature at which the refrigerant reaches its saturation point, i.e., the temperature at which it changes from liquid phase to gas phase.
Low pressure sensor	This value shows the pressure of the refrigerant in the evaporator.

Parameter	Explanation
(EXV Opening) - Electronic expansion valve opening	The EXV (electronic expansion valve) regulates the flow of refrigerant in the system and is crucial for dispensing the correct amount of refrigerant into the evaporator. The valve's opening determines how much refrigerant enters the evaporator, directly impacting the cooling performance. If the valve is fully closed (0), no refrigerant flows.
(Step Comp. freq.) - Compressor frequency	The compressor's operating frequency controls its speed and output. The frequency directly affects the cooling capacity and allows the system to respond to varying demands.
(Comp. Max freq.) - Compressor maximum frequency	This parameter indicates the maximum available frequency for the compressor, i.e., the highest speed at which the compressor can operate.
Phase current	This shows the amount of current drawn by the compressor. This value is an important indicator of the compressor's energy consumption.
Bus voltage	The bus voltage shows the voltage required to power the system. This voltage ensures the electrical supply to the compressor and other electrical components in the system.
(IPM Temp.) - IPM temperature	The IPM (Intelligent Power Module) temperature indicates the temperature of the electronic modules responsible for system control and energy efficiency.



Parameter	Explanation
#1 Compressor (1#Compressor): (ON-OFF) + operating time	This icon indicates the current status of the first compressor, whether it is turned on (ON) or off (OFF), and displays the operating time.
#2 Compressor (2#Compressor): (ON-OFF) + operating time	Just like the first compressor, this icon indicates the operational status (ON/OFF) of the second compressor and its accumulated operating time so far.
Fresh Water Pump: (ON-OFF) + operating time	This icon shows the current status of the fresh water pump (ON/OFF) and its operating time so far. The fresh water pump ensures the circulation of fresh water within the system, which is essential during the cooling or heating cycle to allow proper heat transfer.

Parameter	Explanation
Sea Water Pump: (ON-OFF) + operating time	This icon indicates the operational status (ON/OFF) of the sea water pump and its operating time. The sea water pump ensures the flow of sea water, which is used by the system to cool the condenser during the cooling cycle.
4-way valve: (ON-OFF)	This valve controls the system mode, switching between cooling and heating. The OFF state indicates that the valve is not switching modes, while the ON state indicates that the valve is actively operating, allowing the switch between cooling and heating modes.
Electric Heating: (ON-OFF)	This indicates the status of the electric heating (ON/OFF). In MBC VFD systems, the electric heating can be individually controlled on the fan coil units, allowing heating in each room independently. The ON state means the electric heating is active, and the OFF state indicates it is inactive.
Fresh Water Inlet Temperature (F/W In)	This value shows the temperature of the fresh water returning to the system. The fresh water inlet temperature is a key indicator, as it shows how much the water has heated during circulation in the system and how much cooling is required for the next cycle.
Fresh Water Outlet Temperature (F/W Out)	This value shows the temperature of the fresh water exiting the system, indicating the temperature of the water being discharged by the system. The difference between the outlet and inlet temperatures helps determine the efficiency of the system's cooling or heating performance.
Sea Water Inlet Temperature (S/W In)	This value indicates the temperature of the sea water entering the condenser. The temperature of the incoming sea water is important for the system's cooling efficiency, as colder sea water allows better heat dissipation in the condenser.
Sea Water Outlet Temperature (S/W Out)	This value shows the temperature of the sea water exiting the condenser. The sea water outlet temperature indicates how much heat the sea water has absorbed from the cooling system and how successfully it has carried away excess heat from the condenser.

Service Menu Information for Variable Chiller Air Conditioning Units

The service menu of the MBC Marine Variable Chiller air conditioning units provides access to detailed settings and fine-tuning of the equipment. Access to the service menu is restricted to authorized personnel only and requires a unique PIN code for entry. The parameters in the menu allow fine-tuning of cooling and heating modes, regulation of compressor and sensor operations, and continuous monitoring of the system status.

LIMIT PARAMETERS:

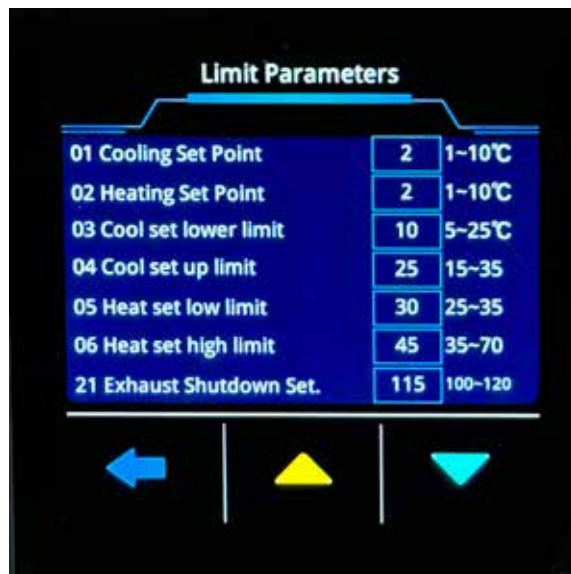

Limit Parameters		
01 Cooling Set Point	2	1-10°C
02 Heating Set Point	2	1-10°C
03 Cool set lower limit	10	5-25°C
04 Cool set up limit	25	15-35
05 Heat set low limit	30	25-35
06 Heat set high limit	45	35-70
21 Exhaust Shutdown Set.	115	100-120

Parameter	Explanation
1. Cooling set point 1-10°C	This is the cooling point, the temperature range within which the system aims to maintain the cooling cycle. Generally, this is the target temperature at which the system automatically activates cooling.
2. Heating set point 1-10°C	This is the heating point, the temperature range within which the heating cycle operates. The system activates heating mode when the temperature reaches this value.
3. Cool set lower limit 5-25°C	This defines the minimum temperature that can be set for cooling. Users cannot set a cooling temperature lower than this value.
4. Cool set upper limit 15-35°C	This is the maximum adjustable temperature for the cooling point. The system will not cool if the desired temperature exceeds this limit.
5. Heat set low limit 25-35°C	This is the lowest settable temperature for the heating cycle. Users cannot set a lower temperature for heating than this value.
6. Heat set high limit 35-70°C	This is the highest settable temperature for the heating cycle. Users cannot set a higher temperature for heating than this value.
21. Comp. Shutdown set (Compressor Shutdown Temperature): 100-120°C	This setting is related to compressor protection. If the compressor's temperature reaches this value, the system will automatically shut down the compressor to prevent overheating and damage. The shutdown temperature can be set between 100°C and 120°C.

COMPRESSOR PARAMETERS:

Comp. Parameters		
07 Min running time of comp.	20	30-120s
08 Min stop time of comp.	180	30-240s
09 Energy loading cycle	60	10-180s
10 Energy down cycle	10	30-180s
19 Oil return frequency	55	30-60Hz
20 Oil return time	5	1-10h

Parameter	Explanation
7. Minimum Running Time of Compressor - 30-120s	This parameter determines how long the compressor must run before it can shut down. It prevents the compressor from cycling on and off too frequently, which could damage the system. Longer run times result in better energy efficiency and extended lifespan.
8. Minimum Stop Time of Compressor - 30-240s	This parameter sets the minimum time the compressor must remain off before restarting. It helps prevent excessive startups, which can cause mechanical stress and helps maintain energy efficiency.
9. Energy Loading Cycle - 10-180s	This parameter regulates the timing and speed of power input or the compressor's output increase. Adjusting the energy loading cycle ensures gradual performance increases, improving energy efficiency and smooth operation.
10. Energy Down Cycle - 30-180Hz	This parameter controls how the compressor decreases power output when full capacity is no longer needed. It allows the compressor to gradually reduce performance, preventing abrupt shutdowns, which results in more efficient energy use and longer service life.
19. Oil Return Frequency - 30-60Hz	This parameter defines how often oil is returned to the compressor. Regular oil return is necessary to ensure the compressor is properly lubricated, thus ensuring efficient operation and protecting compressor parts from wear. Too little oil return can cause wear, while too frequent return can lead to energy loss.
20. Oil Return Time - 1-10h	This setting determines how long the oil return process lasts within the compressor system. It is essential for maintaining proper lubrication and ensuring that enough oil returns to the compressor for optimal operation.

FREQUENCY PARAMETERS:



Parameter	Explanation
14. Max Cooling Frequency (70-120Hz)	This setting controls the compressor's maximum frequency during cooling mode. Higher frequencies correspond to greater compressor speeds and increased cooling capacity. The 70-120 Hz range allows the system to adjust its speed based on cooling demand.
15. Max Heating Frequency (70-120Hz)	Similar to the cooling frequency, this parameter governs the compressor's maximum speed during heating mode. The higher frequency enhances heating capacity, and the 70-120 Hz range ensures the system delivers optimal performance based on heating demand.
16. Min Frequency (0-50Hz)	This setting defines the compressor's lowest operating frequency. In the 0-50 Hz range, the compressor slows down to provide minimal output when demand is low, ensuring energy-efficient operation. 0 Hz represents the compressor being fully stopped.
17. Start Frequency (30-60Hz)	This parameter controls the frequency at which the compressor starts. The 30-60 Hz range enables smoother startups, avoiding excessive power consumption or mechanical strain that could result from a rapid start.
18. Start Time (30-180s)	This time setting regulates how long it takes the compressor to reach its operating frequency after startup. The 30-180 seconds interval ensures the system accelerates gradually, preventing sudden load increases, thus enhancing system stability and extending compressor lifespan.

PROTECTION DELAY PARAMETERS:

Protection Delay Parameters		
22 Early start time of pump	60	30-80s
23 CheckTimeOf WaterFlowSwi	15	10-60s
24 Restart time of pump	10	1-10m
25 Delayed stop time of pump	30	30-180s
31 DelayedStartTimeOf 4-way	6	0-20s
32 Low pressure check time	120	5-180s
33 Low pressure confirm time	30	10-90s

Parameter	Explanation
22. Early Start Time of Pump (30-80s)	This parameter determines how soon the pump should start before the compressor to ensure proper water flow before the compressor begins operating. The 30-80 second timing ensures enough water flow at the start of a cooling or heating cycle, preventing dry running or insufficient coolant flow.
23. Check Time of Water Flow Switch (10-60s)	This setting specifies how long the system checks the water flow switch to ensure proper water flow before the cooling or heating cycle begins. The 10-60 second period is sufficient for the system to confirm flow before fully starting the compressor.
24. Restart Time of Pump (1-10m)	This parameter controls how long the pump should remain off before restarting. The 1-10 minute interval ensures the pump does not restart too quickly, which could cause unnecessary wear and energy waste.
25. Delayed Stop Time of Pump (30-180s)	This setting defines how long the pump remains on after the compressor stops. The delay (30-180 seconds) allows the water to continue flowing, cooling the system and preventing overheating or pressure build-up in the refrigerant.
31. Delay Start Time of 4-Way Valve (0-20s)	This parameter controls when the 4-way valve activates after the system signals a mode change (between cooling and heating). The 0-20 second delay ensures proper pressure equalization before the valve switches.
32. Low Pressure Check Time (5-180s)	This setting determines how long the system monitors the low-pressure sensor before triggering an alarm or shutdown. The 5-180 second window ensures the system detects sustained low pressure before reacting to prevent damage.
33. Low Pressure Confirm Time (10-90s)	This parameter defines how long the system waits before confirming low pressure as a fault. This delay provides time to check whether the low pressure is temporary or a persistent issue that requires an alarm or shutdown.

TEMP. PROTECTION PARAMETERS:

Temp. Protection		
34 Heat High Temp. Point	60	50-80°C
35 Cool Low Temp. Point	3	0-10°C
36 Temp. difference setting	10	0-20°C
37 Cool CoolingWater too Low	5	1-20°C
38 Heat CoolingWater too low	1	0-25°C
39 Cool CoolingWater too high	40	35-55°C
40 Heat CoolingWater too high	35	30-50°C

Parameter	Explanation
34. Heat high temp. point (50-80°C)	This setting defines the temperature at which the heating cycle will shut down due to excessively high temperatures. If the system reaches or exceeds this value, the protection mechanism engages to stop heating and protect the system from overheating.
35. Cool low temp. point (0-10°C)	This parameter sets the minimum temperature for the cooling cycle. If the temperature drops too low (within this range), the system will stop cooling to prevent freezing or overcooling.
36. Temp. difference setting (0-20°C)	This parameter regulates the acceptable temperature difference within the system. It monitors the difference between inlet and outlet temperatures and adjusts operations to maintain optimal performance, avoiding significant temperature variation in the cooling or heating loops.
37. Cool cooling water too low (1-20°C)	This setting defines the minimum temperature of the seawater in the cooling loop. If the seawater temperature drops below this threshold, the cooling cycle will stop to avoid freezing or damage to the cooling system.
38. Heat cooling water too low (0-25°C)	This setting defines the minimum seawater temperature for the heating cycle. If the seawater temperature is too low, the heating cycle will stop, as heating with overly cold water would be inefficient.
39. Cool cooling water too high (35-55°C)	This sets the maximum seawater temperature for the cooling cycle. If the seawater temperature exceeds this value, the system will stop cooling to prevent overheating and damage to the system.
40. Heat cooling water too high (30-50°C)	This parameter specifies the maximum seawater temperature for the heating cycle. If the seawater temperature exceeds this limit, the system will shut down the heating cycle to avoid overheating and protect the system.

COOL EXV PARAMETERS:

Cool EXV Parameters		
41 Initial opening	350	0-500
42 Holding time of opening	120	10-600s
43 Target superheat	4	-10-10°C
44 Min opening	50	0-500
45 Regulation Period	20	0-255s
54 Exhaust temp. cannot DEC	95	80-120

Parameter	Explanation
41. Initial opening (0-500)	This parameter controls the initial opening of the electronic expansion valve (EXV) at the start of the cooling cycle. A higher value (0-500) corresponds to a greater valve opening, allowing more refrigerant to flow through.
42. Holding time opening (10-600s)	This parameter defines how long the EXV remains in its initial opening position before adjusting. Maintaining this setting helps ensure stable flow during the cooling cycle.
43. Target superheat (-10 to 10°C)	Superheat refers to the temperature difference when the refrigerant transitions from liquid to gas. This setting controls the desired superheat level, with negative values indicating lower superheat and positive values indicating higher superheat.
44. Min opening (0-500)	This parameter specifies the EXV's minimum opening position, ensuring that the valve never fully closes. This setting guarantees a minimum refrigerant flow through the system, even at low demand.
45. Regulation period (0-255s)	This parameter controls how frequently the EXV adjusts its opening position. A shorter period results in more frequent adjustments, while a longer period provides smoother operation with fewer changes.
54. Pressure temp. cannot DEC (80-120°C)	This setting regulates the maximum pressure gas temperature from the compressor. If the temperature reaches this value, the system prevents further increases to protect the compressor. The range of 80-120°C is designed to prevent overheating

HEAT EXV PARAMETERS:

Heat EXV Parameters		
46 Initial opening	150	0-500
47 Holding time of opening	120	10-600s
48 Target superheat	4	-10-10°C
49 Min opening	50	0-500
50 Regulation Period	25	0-255s
55 EXV Increase temp.	5	1-10°C

Parameter	Explanation
46. Initial opening (0-500)	This setting defines the initial opening value for the electronic expansion valve (EXV) at the start of the heating cycle. It regulates how much refrigerant is allowed to flow when heating begins.
47. Holding time opening (10-600s)	This setting determines how long the EXV maintains its initial opening position before any further adjustments are made. It helps stabilize the heating process in the early stages of operation.
48. Target superheat (-10 to 10°C)	This parameter sets the target superheat for the heating cycle. Superheat is the temperature difference at the end of the heating cycle that indicates how much heat the refrigerant has absorbed. This value is crucial for energy efficiency and system stability.
49. Min opening (0-500)	This parameter sets the minimum opening value for the EXV during the heating cycle. It ensures a constant minimum flow of refrigerant through the system, even when heating demand is low.
50. Regulation period (0-255s)	This setting determines how frequently the EXV adjusts its position to meet the heating demands. A shorter period results in quicker adjustments, while a longer period provides more stable operation.
55. EXV Increase temp. (1-10°C)	This parameter specifies the temperature range within which the EXV increases its opening. If the refrigerant temperature exceeds this range, the EXV opens further to allow more refrigerant to flow, maintaining optimal heat exchange.

RESONANCE FREQUENCY PARAMETERS:

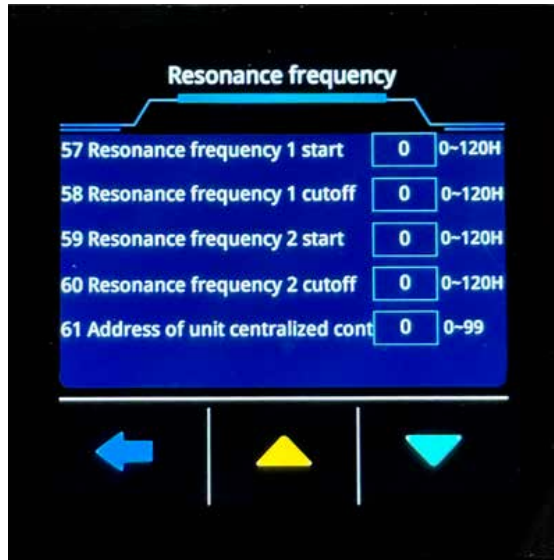

Parameter	Explanation
57. Resonance frequency 1 start (0-120Hz)	This parameter defines the frequency at which the system starts avoiding resonance. Compressors or other moving parts can resonate at certain frequencies, which can damage the equipment. This setting helps the system bypass such frequencies.
58. Resonance frequency 1 cut off (0-120Hz)	This parameter sets the frequency at which resonance avoidance ends. The system can resume normal operation beyond this frequency, ensuring smooth performance without resonance-related issues.
59. Resonance frequency 2 start (0-120Hz)	This is the starting value for a second frequency range in which the system avoids resonance. If the system operates in multiple resonance-prone frequency ranges, this secondary range can be configured here.
60. Resonance frequency 2 cut off (0-120Hz)	This setting defines when the second resonance avoidance period ends, allowing the system to function normally beyond this point.
61. Address of unit centralized control (0-99)	This parameter assigns an address to the unit within a centralized control system, particularly useful in networks of multiple units. Each unit has a unique address (0-99) so the central controller can manage them individually.

STANDBY PROTECTION PARAMETERS:

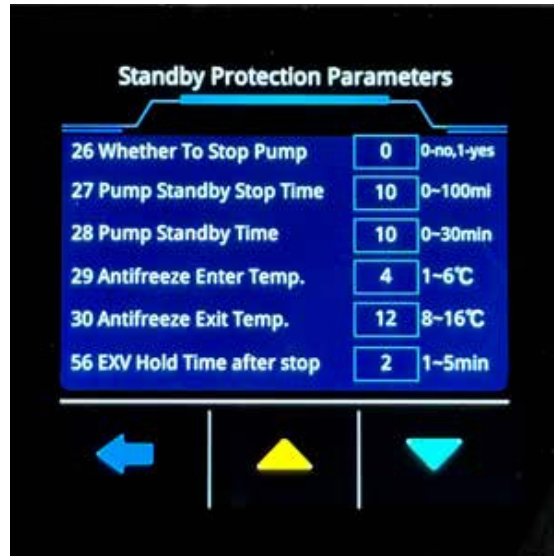

Parameter	Explanation
26. Whether to stop the pump (0-no, 1-yes)	This parameter defines whether the system should stop the pump during standby mode. <ul style="list-style-type: none"> 0: The pump continues running even in standby mode. 1: The pump shuts off during standby to save energy.
27. Pump standby stop time (0-100 min)	This setting determines how long the pump runs before stopping during standby mode. The specified duration ensures that the pump doesn't operate unnecessarily, preventing energy waste when it's not needed.
28. Pump standby time (0-30 min)	This parameter defines how long the pump remains idle in standby before restarting. If the pump is set to restart periodically, it will do so after the specified time.
29. Antifreeze enter temp (1-6°C)	This setting controls the temperature at which the antifreeze function activates. If the system's inlet temperature drops to this value, the antifreeze protection engages to prevent the system from freezing.
30. Antifreeze exit temp (8-16°C)	This parameter defines the temperature at which the antifreeze protection deactivates. When the outlet water temperature reaches this value, the system resumes normal operation as freezing risk subsides.
56. EXV hold time after stop (1-5 min)	This setting determines how long the electronic expansion valve (EXV) remains open after the system shuts down. This ensures that the refrigerant flow completes its cycle, avoiding residual pressure in the system after shutdown.

LEGAL DISCLAIMERS AND LIABILITY

MBC Marine has prepared this installation and user guide based on the most current information available. However, due to the nature of its use, the guide does not cover all possible user needs or questions. We recommend contacting our experts for any specific inquiries or unique requirements.

While every precaution has been taken to ensure the accuracy of this guide, MBC Marine is not liable for any errors or omissions, nor for any damages arising from the proper or improper use of the product or the information provided herein.

No part of this publication may be reproduced, translated, stored in a retrieval system, or transmitted in any form or by any means, whether electronic, mechanical, photocopying, recording, or otherwise, without prior written permission from MBC Marine.

WARRANTY TERMS

These Warranty Terms apply only to sales of new units and accessories (hereinafter “the **Products**”) made by DFR Yachting Kft. (hereinafter “the **Company**”) to the benefit of a Partner belonging to the Company distribution network.

By Partner, this means any natural or legal person approved by Company who purchases the Products within the framework.

These warranty terms do not in any way limit any rights which, due to law applicable to reselling the Product to a sub-purchaser, cannot be excluded or restricted.

The Partner shall be solely responsible for the arrangements of sale and warranties applicable to reselling the Product to the sub-purchaser, regardless of their quality.

CONTRACTUAL WARRANTIES

The contractual warranties mentioned below are granted only to the Partner, who acknowledges and declares that it shall have the material resources, specific knowledge and technical skills to carry out the services (including installation and after-sales services), furthermore undertakes that through its qualified, trained personnel, it shall provide these services in perfect quality with proper diligence and skills.

Products benefit from a contractual warranty for all hidden defects for a duration of 2 (two) year starting from the Product delivery date by the Partner to customer (the “**Customer**”). If requested by Company, the delivery date shall be proven by the Partner with proper documentation (handover protocol, signed and filled out warranty card etc.).

This warranty includes the replacement or repair (chosen by Company) of all parts, recognised as faulty by Company. The repair time is not included in Company warranty period; and no replacement unit shall be provided by Company either to the Partner or to the Customer for this period.

Products sold by Company to the Partner are subject to these warranty terms which shall be in lieu of all other Company warranties, whether express or implied. The Partner is not authorized to assume or undertake, on Company’s behalf, any liabilities in connection with the Partner’s sale of Product other than as set forth in these warranty terms. The Partner shall identify and hold Company harmless with respect to any undertakings, assumptions or representations made by the Partner beyond those which are included in these warranty terms.

SPECIFIC WARRANTY

The 2-year contractual warranty does not apply to Products being used for commercial gain (any hiring or chartering activity falls into this category), since these Products may be covered by a duration of 1 (one) year warranty which is starting from the Product delivery date by the Partner to the Customer. If requested by Company, the delivery date shall be proven by the Partner with proper documentation (handover protocol, signed and filled out warranty card etc.).

ARRANGEMENTS FOR IMPLEMENTING THE WARRANTIES

If a warranty claim arises, the Partner must notify the Company by email (info@myboatclima.com) within a maximum of eight (8) days from the receipt of the claim. This does not affect the Partner's obligation to investigate and evaluate the case before informing Company on the claim received.

Any claim will also be required to quote the serial number of the Product concerned, and where applicable the serial number of the part(s) involved in the warranty claim, along with all supporting documents (brief description with photos and videos). Furthermore, the claim shall indicate the exact circumstances under which the problem occurred.

Company may, in order to investigate the claim, ask for any details and demand any necessary supporting evidence.

Company shall assess the claim and inform the Partner whether the defect is subject to Company warranty or a result of non-appropriate use / maintenance of the Product, which is not covered by Company warranty.

Immobilization of the Product following problems encountered and/or replacement and/or repair work, whatever the duration, does not create entitlement to compensation.

Company shall not, under any circumstances, be liable for transport fees, customs duties and other ancillary expenses, except as otherwise stated below.

If the claim can be handled locally and the cost of repair shall not be more than EUR 150 + VAT, the repair and/or replacement shall be carried out by the Partner at the expense of Company. Company shall not bear any other cost in relation to the repair. The cost of the repair shall be invoiced by the Partner within 15 days.

Should the nature of the repairs require the work under warranty to be carried out in Company's workshop or in a place different to the place where the Product is situated and the cost of the repair is expected to exceed EUR 150+VAT, the Company shall have it repaired or replaced (if the defect cannot be repaired), after it verifies that the defect indeed falls within Company warranty terms. The cost of returning the defective Product to Company shall be paid by the Customer. The cost of return shipping by Company to the Customer and the cost of repair, if any, shall be borne by Company, which additionally shall not accept fees for taking out and returning to boat if the Product needs to be taken out.

The defective Product shall, in all cases, be returned to Company in its original packaging.

EXCLUSIONS FROM THE SCOPE OF CONTRACTUAL WARRANTY

The following are excluded from contractual warranties:

- damage resulting from normal wear and parts needing to be replaced regularly (filter, etc.);
- non-original parts and/or modified/altered original parts and/or
- the consequences of the installation of these parts and said transformations or modifications;
- damages arising from poor maintenance, abusive usage or negligence, misuse, submergence, improper application or use contrary to instructions;
- damage related notably to an accident or following a fire, an explosion, a natural catastrophe, corrosion or slow degradation or any phenomenon of any kind;
- damages resulting from improper or faulty installation, installation that does not comply with Company's instructions or otherwise and any damage resulting from such;
- damages resulting from lack of regular preventative maintenance as outlined in the user manual;
- items not manufactured by Company;
- Company Products used by or applied by the owner as an integral part of products not manufactured by Company;
- additional charges associated with the removal, reinstallation, or replacement of any equipment or furnishings beyond the particular covered Product;
- the travel costs of the servicing staff of the Partner in excess of 1.0 (one) hour;
- damages related to the pumps with cracked heads or pumps that have been run dry, water damaged or have blown freeze plugs;
- gauge instrument calibration;
- exterior corrosion;
- water damage, including specifically to the following components: blowers, logic boards and displays heads;
- incorrect programming of displays;
- dirty condensers and/or evaporators;
- damages related to the failures resulting from improper winterization;
- product damage as a result of improper return packaging or other freight damage;
- replacement of refrigerant with substitute without Company preauthorization;
- environmental and/or Recovery Fees;
- welding and Nitrogen Fees. Installation and application of Products are not warranted by Company unless installation was performed in house because Company has no control or authority over the selection, location, application, or installation of Products.



info@myboatclima.com
mbc-marine.com
+36 30 9773774